

090(2.3) SMT DL Series

SEALED

090(2.3) SMT DL Series is a compact wire-to-wire sealed connector solution.

Mechanical lock system designed to endure extreme vibration and extended life requirements.

Mechanical lock system provides an audible click when housings are mated.

Low insertion force, high contact reliability.

Provides (IPX7 of IEC 60529) Waterproof.

■ CONSTRUCTION

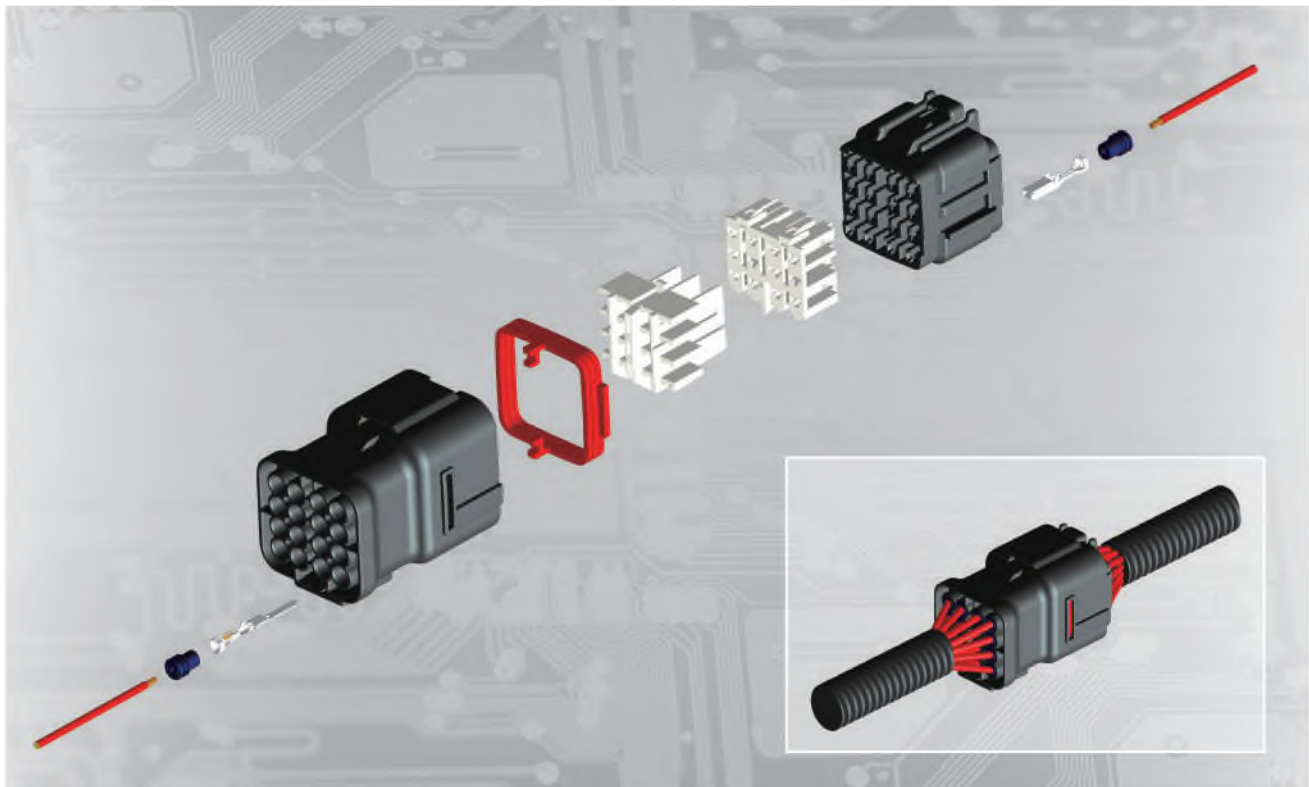

■ SPECIFICATIONS

Material	Connector	PBT
	Male Terminal	BRASS
	Female Terminal	COPPER ALLOY
Operating Temperature Range		-40°C~120°C
Voltage Drop		3mV/A
Isolation Resistance		100MΩ
Dielectric Resistance		1000V
Applicable Wire Size AWG / mm ²		22 AWG~14 AWG(0.3mm ² ~2.0mm ²)
Maximum Electric Current		10A

090(2.3) SMT DL Series

SEALED

TERMINAL

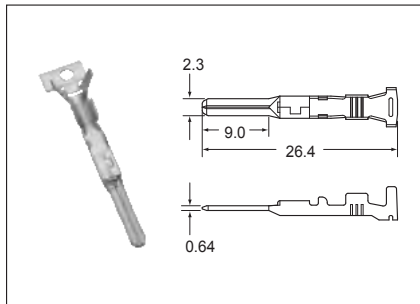

ITEM NO.	WIRE RANGE		MATERIAL	PLATINGS	Q'TY REEL	APPLICATOR	DIES
	A.W.G.	mm ²					
1101A0050	22-20	0.3-0.5	Brass	Pre-Tin	4000	CDM-94107-S	CDT-94107-S
1101A0051	18-16	0.75-1.25	Brass	Pre-Tin	3500	CDM-94107-M	CDT-94107-M
1101A0052	14-12	1.25-2.0	Brass	Pre-Tin	3500	CDM-94107-L	CDT-94107-L

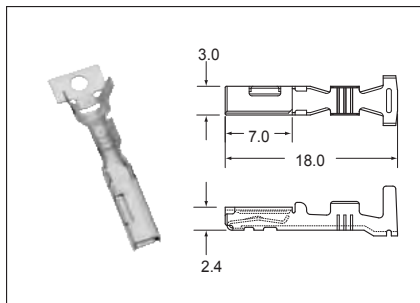

ITEM NO.	WIRE RANGE		MATERIAL	PLATINGS	Q'TY REEL	APPLICATOR	DIES
	A.W.G.	mm ²					
1211A0060	22-20	0.3-0.5	Copper Alloy	Pre-Tin	4000	CDM-94109-S	CDT-94109-S
1211A0061	18-16	0.75-1.25	Copper Alloy	Pre-Tin	3500	CDM-94109-M	CDT-94109-M
1211A0062	16-14	1.25-2.0	Copper Alloy	Pre-Tin	3500	CDM-94109-L	CDT-94109-L

HOUSING

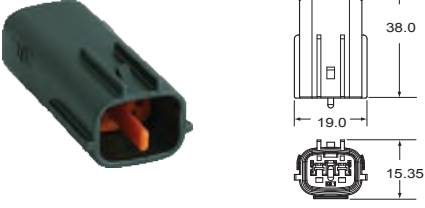
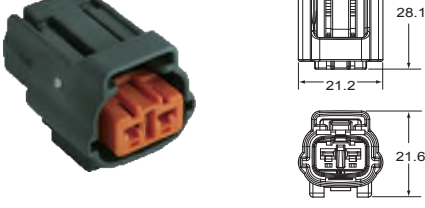
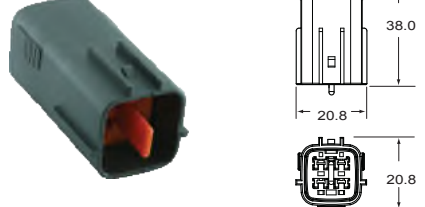
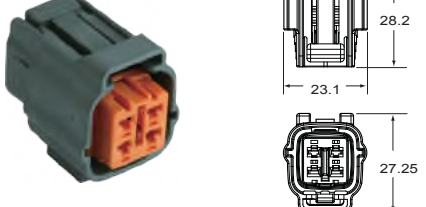







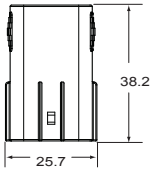
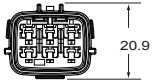

POLE	MALE	FEMALE
2	<p>3102A0639</p>  <p>100 PCS</p>	<p>3202A0639</p>  <p>100 PCS</p>
4	<p>3104A0639</p>  <p>100 PCS</p>	<p>3204A0639</p>  <p>100 PCS</p>

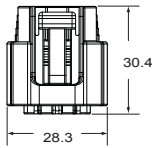
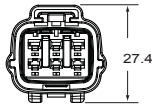
• HOUSING (UNIT: mm)
 MATERIAL : PBT
 COLOR : GREY

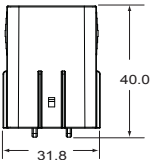
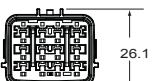
090(2.3) SMT DL Series

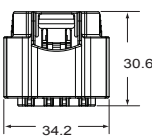
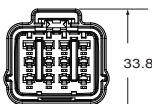
SEALED

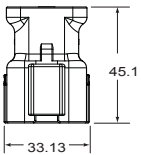
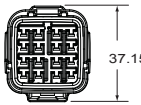
HOUSING

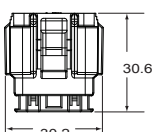
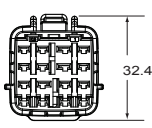
POLE	MALE	FEMALE
6	<p>3106A0639</p>    <p>50 PCS</p>	<p>3206A0639</p>    <p>50 PCS</p>
12	<p>3112A0639</p>    <p>25 PCS</p>	<p>3212A0639</p>    <p>50 PCS</p>
16	<p>3116A0639</p>    <p>25 PCS</p>	<p>3216A0639</p>    <p>50 PCS</p>

- HOUSING (UNIT: mm)
- MATERIAL: PBT
- COLOR: GREY

090(2.3) SMT DL Series

SEALED

RUBBER SEAL

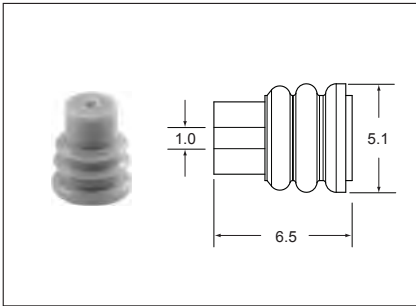

ITEM NO.	MATERIAL	COLOR	Q'TY BAG	WIRE INSULATION DIAMETER(mm)
7001A0639	SILICONE	GREY	1000	1.2-1.7

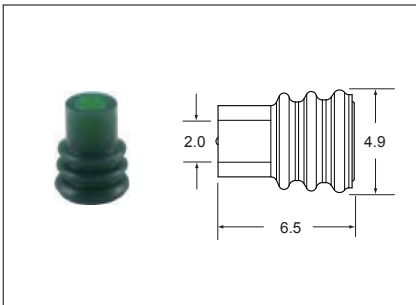

ITEM NO.	MATERIAL	COLOR	Q'TY BAG	WIRE INSULATION DIAMETER(mm)
7001A0647	SILICONE	GREEN	1000	1.5-2.0