

# ELECTRICAL INSTALLATION PRODUCTS

Splicing Connectors and Chassis Mount Terminal Blocks

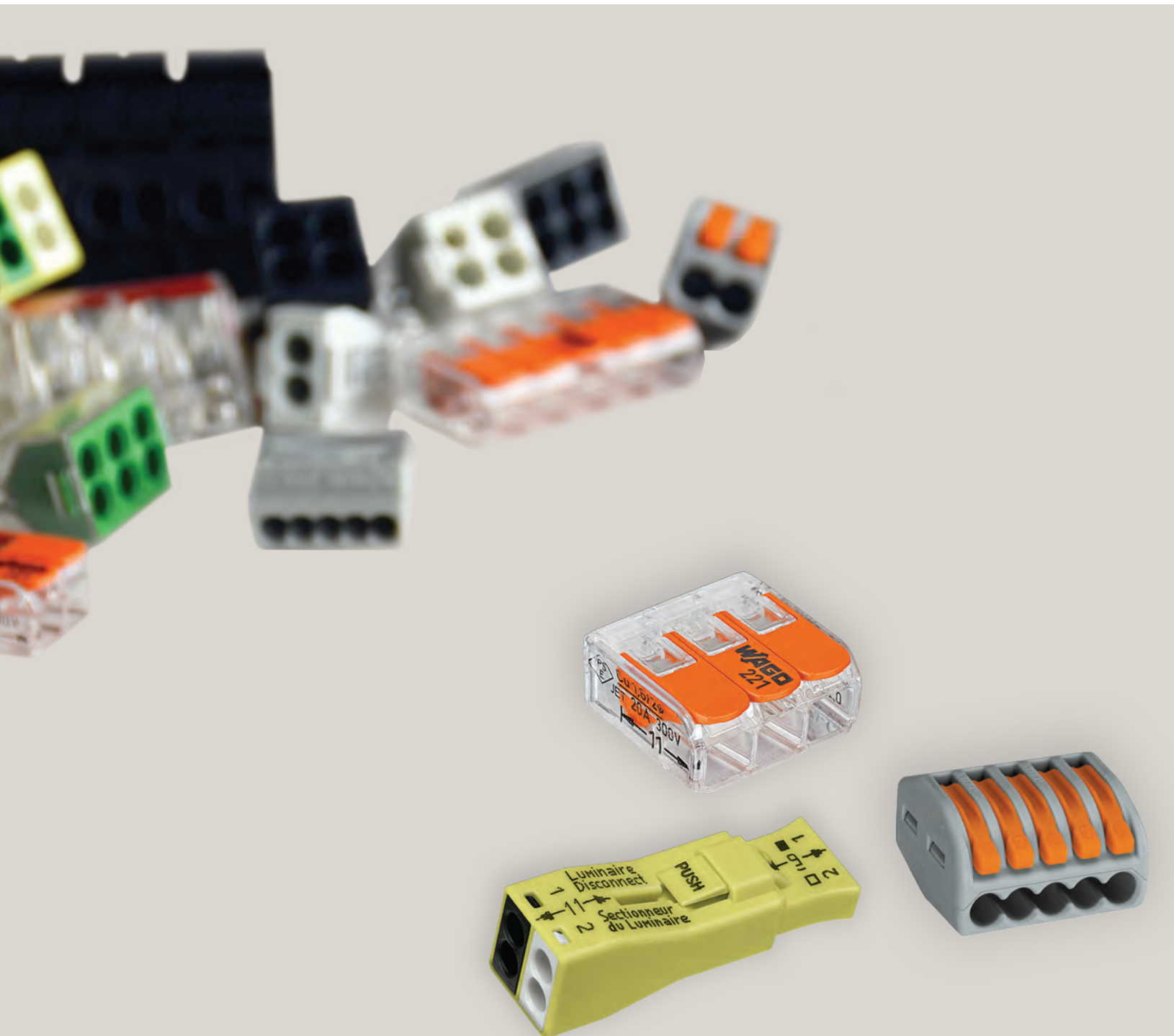

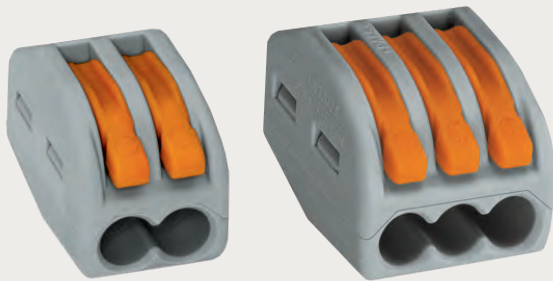
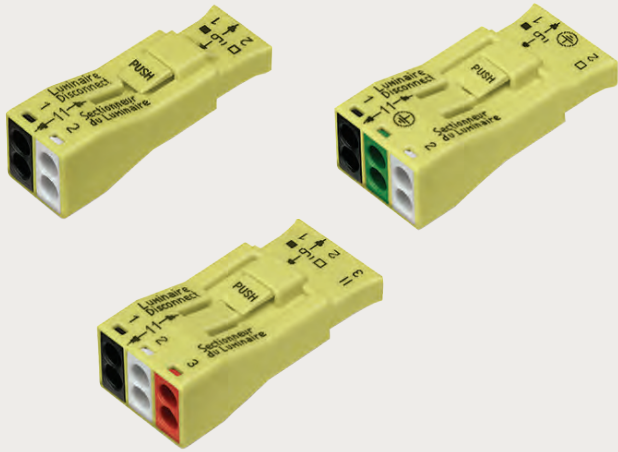

## Contents

<b>221 Series LEVER-NUTS®</b> 12 AWG, 10 AWG, Hazardous Locations	4 – 7
<b>222 Series LEVER-NUTS®</b> The Original Lever-Operated Splicing Connector	8 – 9
<b>Accessories</b> For 221 Series and 222 Series	10 – 11
<b>773 Series WALL-NUTS®</b> PUSHWIRE® Connectors for Junction Boxes	12 – 15
<b>224 Series</b> Inline Connectors	16 – 17



<b>243 Series</b> MICRO PUSHWIRE® Connectors	18 – 19
<b>873 Series</b> PUSHWIRE® Connectors for Luminaire Disconnect	20 – 21
<b>862 Series</b> Chassis Mount Terminal Blocks	22 – 25
<b>Accessories and Operating Tools</b> Operating Tools, Stripping, Cutting, and Crimping Tools, Ferrules, Test and Measurement Devices	26 – 31





# 221 SERIES LEVER-NUTS®

Compact Splicing Connectors for All Wire Types



## 221 SERIES LEVER-NUTS®

- Connect any combination of solid, stranded and flexible copper wires quickly and reliably
- Visually inspect for proper strip length and complete wire insertion through its transparent housing
- Operate comfortably and with lower operating forces by using familiar orange levers

Electrical Data	12 AWG	10 AWG
Rated voltage	600 V (1000 V signs & fixtures)	
Nominal current	20 A	30 A
<b>Wire Size</b>		
Solid conductor	24 - 12 AWG	20 - 10 AWG
Stranded conductor	24 - 12 AWG	20 - 10 AWG
Flexible conductor	24 - 12 AWG	20 - 10 AWG
Strip length	11 mm / 0.43 in.	
Maximum operating temperature	105 °C	
Approvals	   	

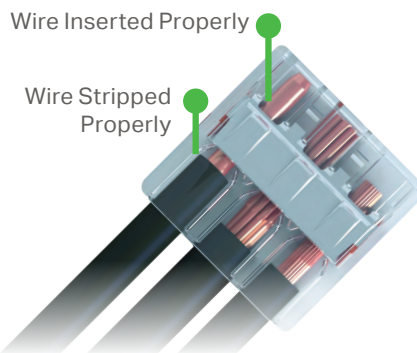
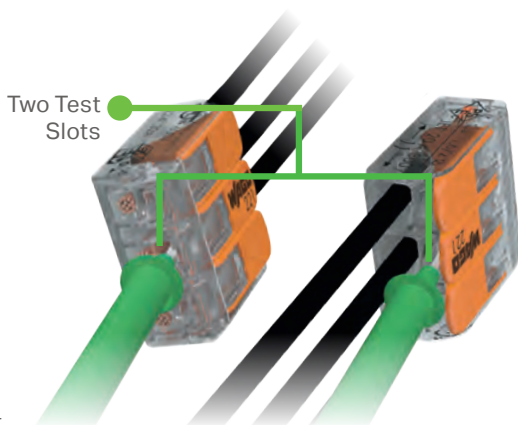

Easily combine various types and sizes of wires

- 12 AWG family: 24 - 12 AWG
- 10 AWG family: 20 - 10 AWG

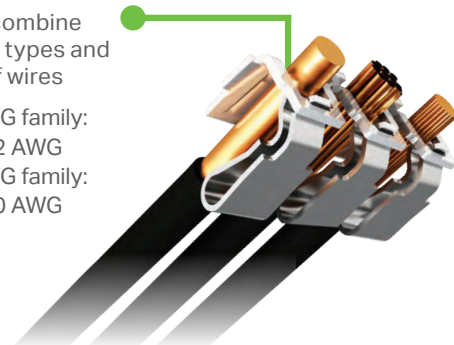

# 221 Series for 12 AWG

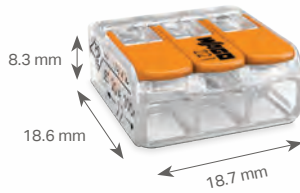
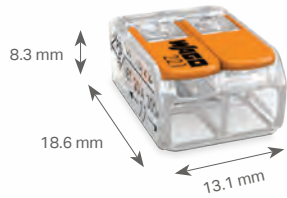

 11 mm / 0.43 in.

 11 mm / 0.43 in.

 11 mm / 0.43 in.

2-conductor connector Transparent housing, orange levers		3-conductor connector Transparent housing, orange levers		5-conductor connector Transparent housing, orange levers	
Item No.	Pack.-unit pcs	Item No.	Pack.-unit pcs	Item No.	Pack.-unit pcs
221-412	1=box of 100 pcs	221-413	1=box of 50 pcs	221-415	1=box of 25 pcs
221-412/VE00-2500	2500 (bulk)	221-413/VE00-2500	2500 (bulk)	221-415/VE00-1000	1000 (bulk)
221-412/996-010	1=10 (clamshell)	221-413/996-010	1=10 (clamshell)	221-415/996-010	1=10 (clamshell)
221-412/K194-4045/000-100	1=jug of 550	221-413/K194-4045/000-100	1=jug of 350	221-415/K194-4045/000-100	1=jug of 225

# 221 Series for 10 AWG

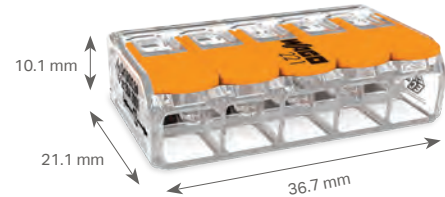
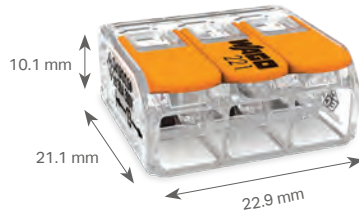
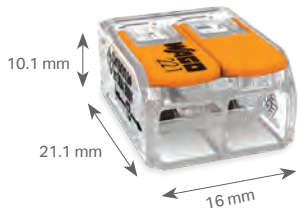

 11 mm / 0.43 in.

 11 mm / 0.43 in.

 11 mm / 0.43 in.

2-conductor connector Transparent housing, orange levers		3-conductor connector Transparent housing, orange levers		5-conductor connector Transparent housing, orange levers	
Item No.	Pack.-unit pcs	Item No.	Pack.-unit pcs	Item No.	Pack.-unit pcs
221-612	1=box of 100 pcs	221-613	1=box of 50 pcs	221-615	1=box of 25 pcs
221-612/VE00-1000	1000 (bulk)	221-613/VE00-1000	1000 (bulk)	221-615/VE00-500	500 (bulk)

# 221 SERIES *LEVER-NUTS*®

For Hazardous Locations

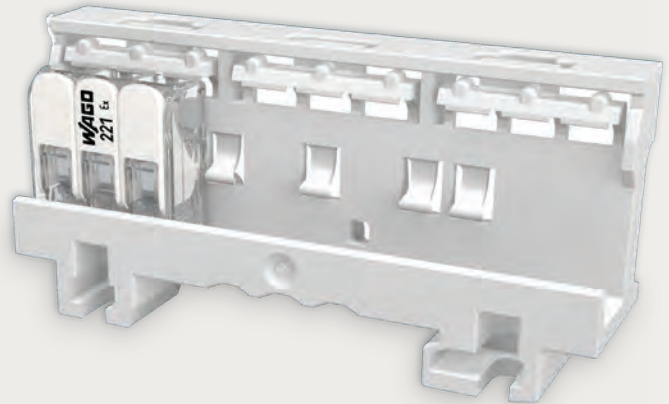

## 221 SERIES *LEVER-NUTS*®

- Easy, fast and reliable connection technology for products in Ex areas
- Must be used with mounting carrier to fulfill Ex requirements
- Mounting carrier can be DIN rail mounted or can be screwed down to a smooth surface
- Excellent for junction boxes in haz-loc applications

### Electrical Data

Rated voltage	440 V with spacing between adjacent connectors
	275 V without spacing
	600 V for general industry

Nominal current 20 A

### Wire Size

Solid conductor	24 - 12 AWG
Stranded conductor	24 - 12 AWG
Flexible conductor	24 - 12 AWG
Strip length	11 mm / 0.43 in.

Maximum operating temperature 105 °C

Approvals



Zone 1, 2



Class 1, Zone 1



Class 1, Zone 1

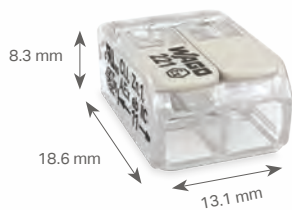

11 mm / 0.43 in.

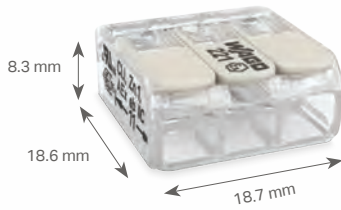

11 mm / 0.43 in.



11 mm / 0.43 in.

**2-conductor connector**  
Transparent housing, white levers

**3-conductor connector**  
Transparent housing, white levers

**5-conductor connector**  
Transparent housing, white levers

Item No.	Pack.-unit pcs	Item No.	Pack.-unit pcs	Item No.	Pack.-unit pcs
221-482	1=box of 100 pcs	221-483	1=box of 50 pcs	221-485	1=box of 25 pcs

## Easy Operation:



Easily open lever by hand and insert conductor

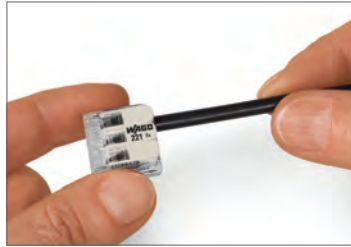

Push lever back down



Install connectors into the mounting carrier



Remove connectors - without tools



Secure the carrier using screws on smooth surfaces



Test inserted connectors in the carrier



Rated 440 V with spacing between adjacent connectors



Rated 275 V with no spacing between connectors

# 222 SERIES *LEVER-NUTS*®

The Original Lever-Operated Splicing Connector

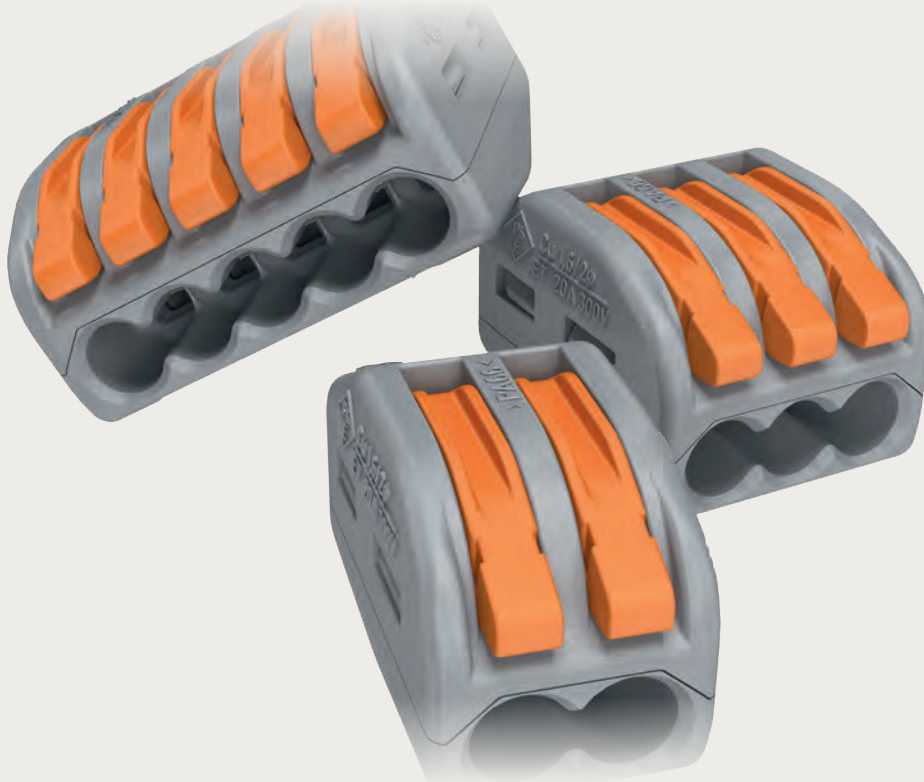



## 222 SERIES *LEVER-NUTS*®

- For all connections requiring stranded or solid wires
- Wide range of wire sizes
- Combination of different wire sizes and types in one connector
- Built-in test point
- Low installed cost and safe operation
- Maintenance-free connection
- Reusable connector

### Electrical Data

Rated voltage	600 V (1000 V signs & fixtures)
Nominal current	20 A

### Wire Size

Solid conductor	28 - 12 AWG 
Stranded conductor	28 - 12 AWG 
Flexible conductor	28 - 12 AWG 
Strip length	9 ... 10 mm / 0.37 in.

Maximum operating temperature	105 °C
-------------------------------	--------

### Approvals



Integrated test port allows for easy testing of connection integrity



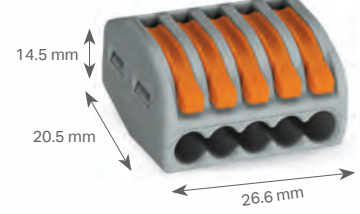
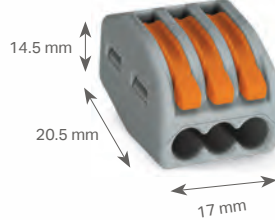
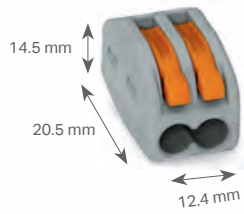

 9 ... 10 mm / 0.37 in.

 9 ... 10 mm / 0.37 in.

 9 ... 10 mm / 0.37 in.

2-conductor connector Gray		3-conductor connector Gray		5-conductor connector Gray	
Item No.	Pack.-unit pcs	Item No.	Pack.-unit pcs	Item No.	Pack.-unit pcs
222-412	1=box of 50 pcs	222-413	1=box of 50 pcs	222-415	1=box of 40 pcs
222-412/PW05-0005	1=blister of 5 pcs	222-413/PW05-0005	1=blister of 5 pcs	222-415/PW05-0005	1=blister of 5 pcs
222-412/PW05-350	1=jar of 350 pcs	222-413/PW05-250	1=jar of 250 pcs	222-415/PW05-150	1=jar of 150 pcs
222-412/VE00-2500	2,500 (bulk)	222-413/VE00-2500	2,500 (bulk)	222-415/VE00-1000	1,000 (bulk)

1) Strip wire

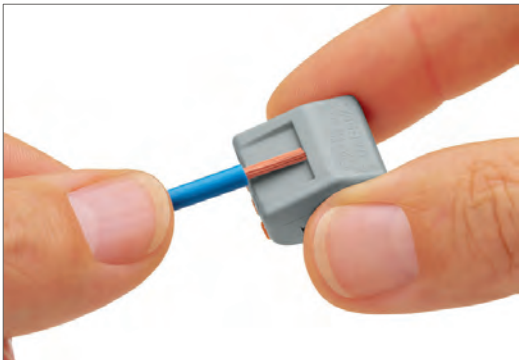

2) Push up lever

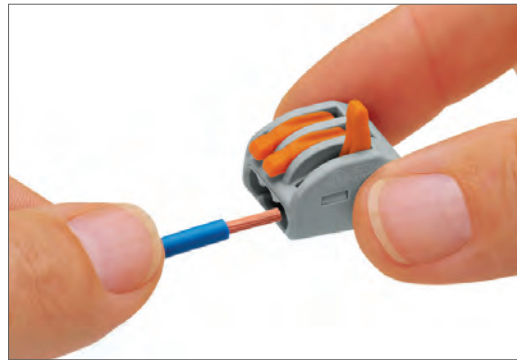

3) Insert conductor and push down lever. Repeat as necessary.

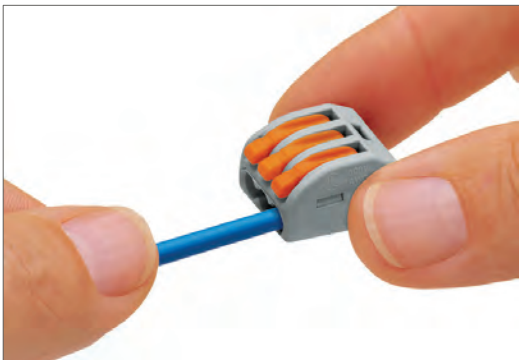

# ACCESSORIES

For 221 and 222 Series

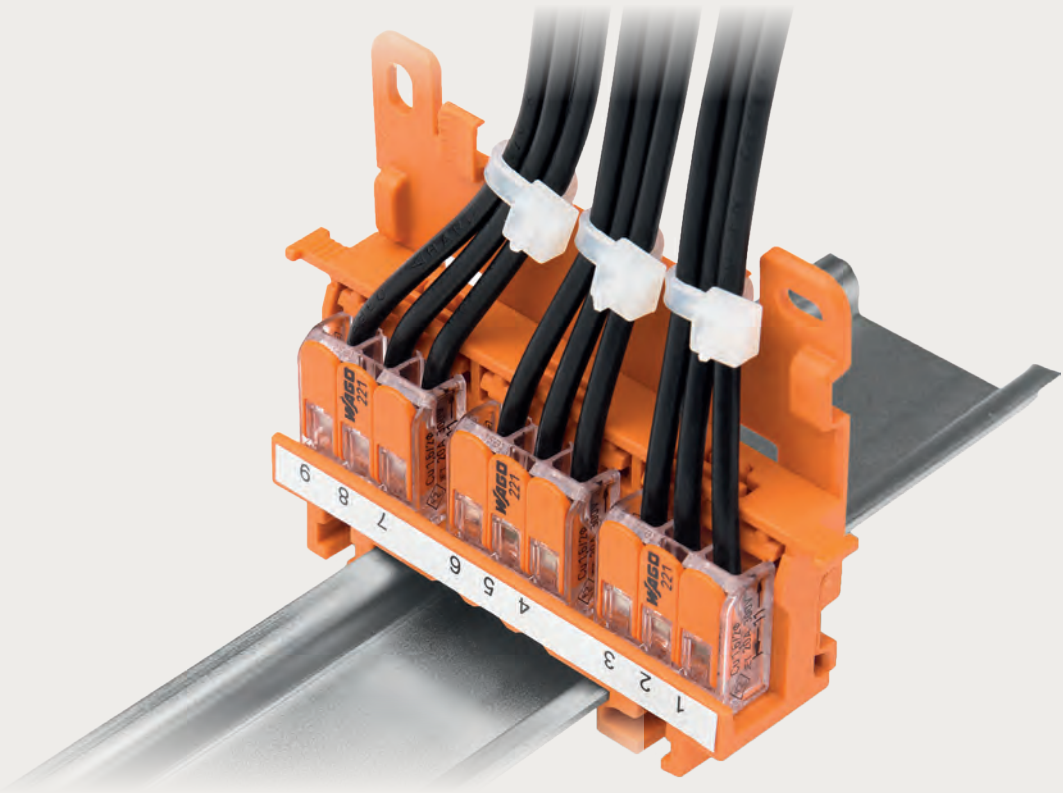

## LEVER-NUTS® CAN DO MORE

Mounting accessories convert these connectors into terminal block solutions:

- Mounting flexibility includes horizontal or vertical; snap to DIN rail or screw mount to flat surface
- Multiple cable tie locations
- Marking surfaces available for circuit identification

### Assembly:

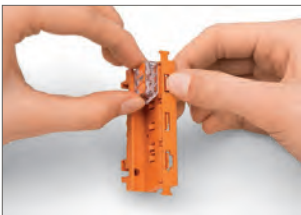

221: Inserting or removing connector from mounting carrier



222: Inserting or removing connector from the end of the carrier, securing with snap lock



Mounting of strain relief plate to the mounting carrier



Snapping the universal right angled adapter on the mounting carrier



Inserting a conductor into the single mounting carrier



Removing a conductor from the single mounting carrier

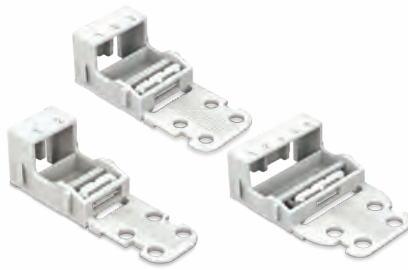

Mounting carriers for 221 Series		Single connector carriers for 221 Series 12 AWG		Operating tools for opening levered splicing connectors	
Item No.	Pack.-unit pcs	Item No.	Pack.-unit pcs	Item No.	Pack.-unit pcs
● 221-500 (12 AWG)	1=box of 10 pcs	○ 221-502 (2-conductor)	1=box of 10 pcs	210-101 (222 Series)	1
● 221-510 (10 AWG)	1=box of 10 pcs	○ 221-503 (3-conductor)	1=box of 10 pcs	210-102 (221 12 AWG)	1
○ 221-501 (Ex)	1=box of 10 pcs	○ 221-505 (5-conductor)	1=box of 10 pcs	210-104 (221 10 AWG)	1



Universal right angled adapter for 221 and 222 Series, combined with mounting carriers for horizontal mounting on DIN rail		Mounting carrier for 222 Series		Strain relief plate for 221 and 222 Series mounting carriers	
Item No.	Pack.-unit pcs	Item No.	Pack.-unit pcs	Item No.	Pack.-unit pcs
● 222-510	10	● 222-500	1=box of 10 pcs	● 222-505	1=box of 10 pcs

## Mounting Options:



Vertical mounting on DIN rail with wire ties providing strain relief



Mounting carrier with strain relief plate mounted vertically on flat surface

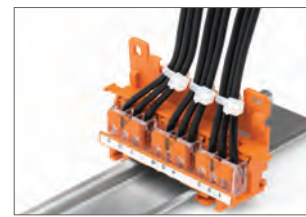

Vertical mounting with strain relief plate on DIN rail. Wiring locations identified by marker strips



Horizontal mounting with strain relief plate on flat surface. Wiring locations identified using marker strips



Horizontal mounting with strain relief plate on DIN rail using angled DIN rail adapter

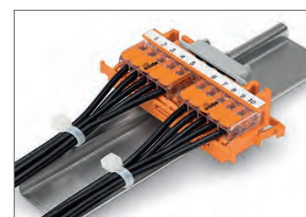

Horizontal mounting on DIN rail using angled DIN rail adapter



Horizontal screw mounting with the single carriers



Vertical screw mounting with the single carriers



Connecting a light to the mains

# 773 SERIES WALL-NUTS®

## PUSHWIRE® Connectors for Junction Boxes

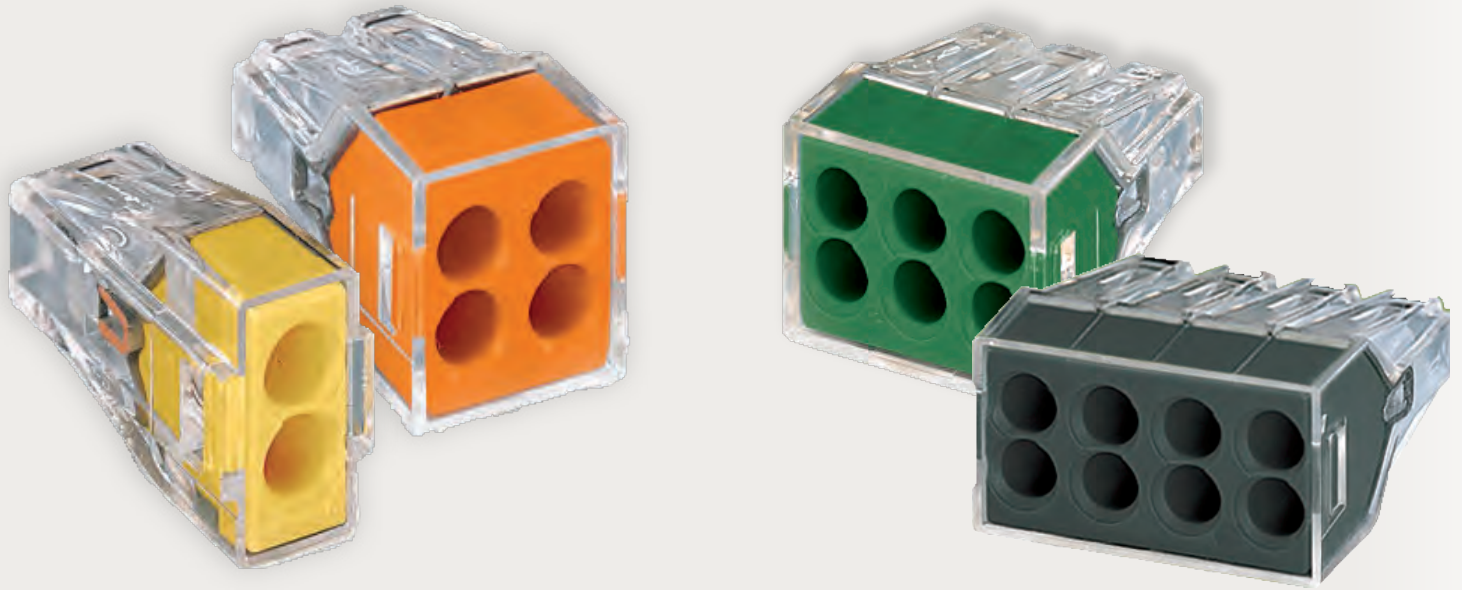



### 773 SERIES WALL-NUTS®

- PUSHWIRE® connection of solid and rigid-stranded wire
- Save up to 50% in wiring time over twist-type connectors
- Transparent housing for visual inspection of complete insertion
- Color-coded for quick identification
- Versions for 10 AWG, high temp, and hazardous locations

#### Electrical Data

Rated voltage	600 V (1000 V signs & fixtures)
Nominal current	20 A
3-conductor only	30 A

#### Wire Size

Solid conductor	18 - 12 AWG	
Stranded conductor (≤ 19 strands)	16 - 12 AWG	
Stranded tin-bonded	22 - 16 AWG	
Solid and stranded (3-conductor only)	14 - 10 AWG	
Strip length	10 ... 13 mm / 0.45 in.	
3-conductor only	12 ... 13 mm / 0.49 in.	
Maximum operating temperature	105 °C	

#### Approvals



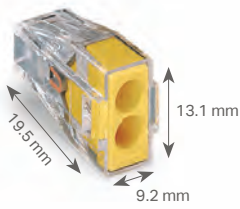

10 ... 13 mm / 0.45 in.

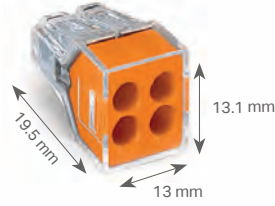

10 ... 13 mm / 0.45 in.

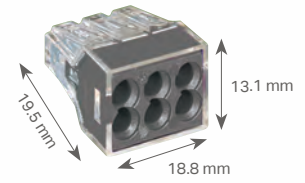

10 ... 13 mm / 0.45 in.

**2-conductor connector**  
Transparent housing, yellow face

Item No.	Pack.-unit pcs
● 773-162	1=box of 100 pcs
● 773-162/PW25-0010	1=blister of 10 pcs
● 773-102/PW05-650	1=jar of 650 pcs
● 773-102/VE00-0500	500 (bulk)
● 773-102/VE00-2500	2,500 (bulk)
● 773-112 (for grounding)	1=box of 100 pcs

**4-conductor connector**  
Transparent housing, orange face

Item No.	Pack.-unit pcs
● 773-164	1=box of 100 pcs
● 773-164/PW25-0010	1=blister of 10 pcs
● 773-104/PW05-400	1=jar of 400 pcs
● 773-104/VE00-0500	500 (bulk)
● 773-104/VE00-2500	2,500 (bulk)
● 773-114 (for grounding)	1=box of 100 pcs

**6-conductor connector**  
Transparent housing, black face

Item No.	Pack.-unit pcs
● 773-166	1=box of 50 pcs
● 773-166/PW25-0010	1=blister of 10 pcs
● 773-106/PW00-250	1=jar of 250 pcs
● 773-166/VE00-0500	500 (bulk)
● 773-166/VE00-2500	2,500 (bulk)
● 773-116 (for grounding)	1=box of 50 pcs



10 ... 13 mm / 0.45 in.

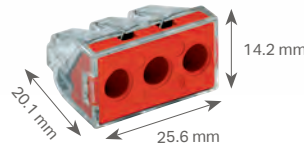

12 ... 13 mm / 0.49 in.

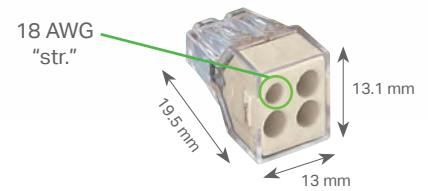

10 ... 13 mm / 0.45 in.

**8-conductor connector**  
Transparent housing, dark gray face

Item No.	Pack.-unit pcs
● 773-168	1=box of 50 pcs
● 773-168/PW25-0010	1=blister of 10 pcs
● 773-108/VE00-2500	2,500 (bulk)
● 773-118 (for grounding)	1=box of 50 pcs

**3-conductor connector for 10 AWG**  
Transparent housing, red face

Item No.	Pack.-unit pcs
● 773-173	1=box of 50 pcs
● 773-173/PW25-0005	1=blister of 5 pcs
● 773-173/PW05-200	1=jar of 200 pcs
● 773-173/VE00-0500	500 (bulk)
● 773-173/VE00-2500	2,500 (bulk)

**4-conductor connector**  
with special port for 18 AWG stranded wire  
Transparent housing, light gray face

Item No.	Pack.-unit pcs
○ 773-124	1=box of 100 pcs
○ 773-124/VE01-0000	2,500 (bulk)

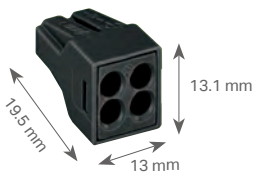

10 ... 13 mm / 0.45 in.

**4-conductor connector**  
for high temperature applications up to 150 °C  
Black housing, black face

Item No.	Pack.-unit pcs
● 773-514	50

# 773 SERIES WALL-NUTS®

## For Ex Applications

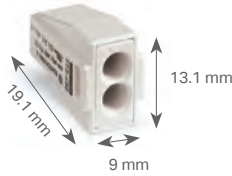

10 ... 13 mm / 0.45 in.

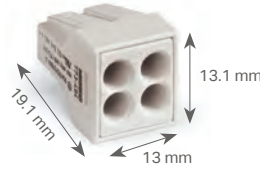

10 ... 13 mm / 0.45 in.

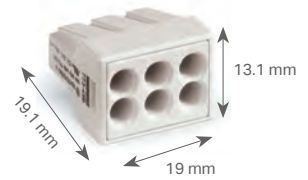

10 ... 13 mm / 0.45 in.

2-conductor pushwire connector		4-conductor pushwire connector		6-conductor connector	
Item No.	Pack.-unit pcs	Item No.	Pack.-unit pcs	Item No.	Pack.-unit pcs
○ 773-492 ☉	100	○ 773-494 ☉	100	○ 773-496 ☉	100

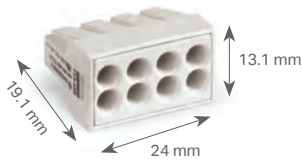

10 ... 13 mm / 0.45 in.









12 ... 13 mm / 0.49 in.

8-conductor pushwire connector		3-conductor pushwire connector for 10 AWG	
Item No.	Pack.-unit pcs	Item No.	Pack.-unit pcs
○ 773-498 ☉	100	○ 773-493 ☉	50

### Highlights:

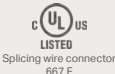
- Compact design allows a high concentration of more connectors in an Ex junction box or Ex terminal box resulting in space-savings and cost-effective installation solutions
- Easy wiring provides time-saving installation
- Resistance to vibration (shock-proof)
- Built-in test slot for easy troubleshooting
- Maintenance-free connection

Electrical Data	
Rated voltage	550 V
Nominal current	24 A
3-conductor only	42 A
Wire Size	
Solid conductor	18 - 12 AWG 
Stranded conductor (≤ 19 strands)	16 - 12 AWG 
Stranded tin-bonded	22 - 16 AWG 
Solid and stranded (3-conductor only)	14 - 10 AWG
Strip length	10 ... 13 mm / 0.45 in.
3-conductor only	12 ... 13 mm / 0.49 in.
Maximum operating temperature	105 °C
Approvals	  

# Mounting Carriers for WALL-NUTS®



Mounting carrier for Ex applications light gray		Mounting carrier for pushwire connectors orange	
Item No.	Pack.-unit pcs	Item No.	Pack.-unit pcs
○ 773-331 ☉	10	● 773-332	10

## Assembly:



Simple insertion of 773 into carrier - no tools required



End stops are locked in place to secure the connectors

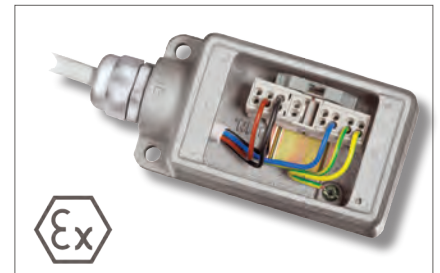

For hazardous applications, this 773 Series MUST be used in conjunction with the mounting carrier specified on this page (item number 773-331).



Mounting carrier with connectors snaps on DIN rail



Removal of carrier from DIN rail

Certification according to ATEX / UL Ex is based upon the use of the entire system (connector and mounting carrier).



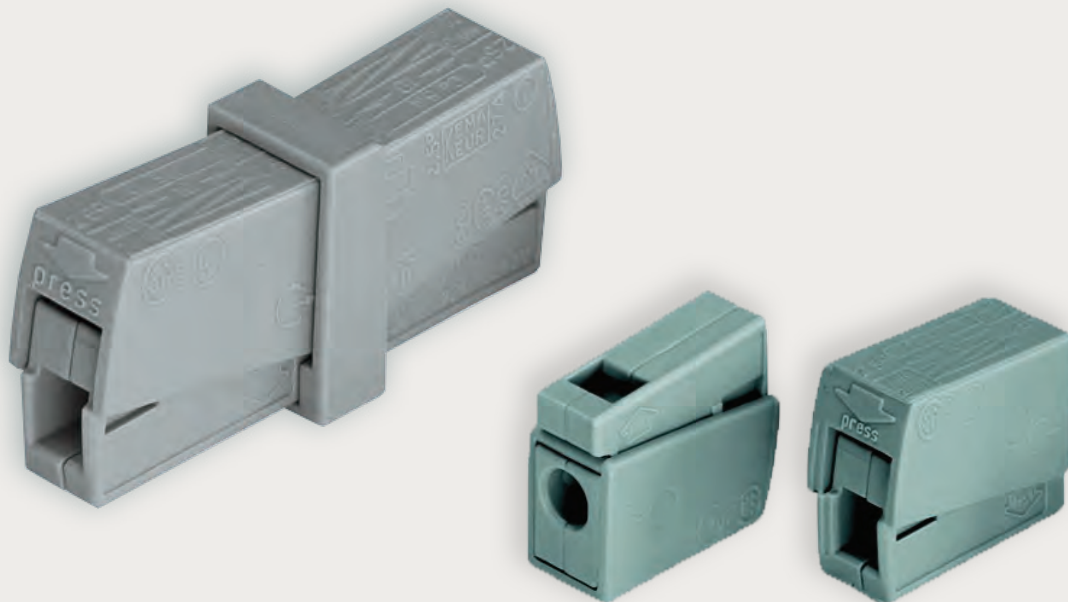

# 224 SERIES INLINE CONNECTORS

PUSHWIRE® and Squeeze-to-Open



## 224 SERIES

- Connect solid line-side wire with flexible or stranded load-side wire (eg. ceiling fan or light fixture)
- PUSHWIRE® connect to line side; squeeze to connect load side
- Daisy chain power with 2-conductor line-side versions
- Perfect for use in ceiling fan or fixture installations

Electrical Data		
Rated voltage	300 V	
Nominal current	20 A	
Wire Size	Line Side	Load Side
224-101/224-104	14 - 12 AWG sol	20 - 16 AWG sol / str / flx
224-112/224-114	2x 16 - 14 AWG sol	20 - 16 AWG sol / str / flx
224-201	20 - 16 AWG sol / str / flx (line and load side)	
Strip length	9 ... 11 mm / 0.39 in.	
Maximum operating temp.	105 °C (120 °C)	
Approvals	    	

- The perfect in-line connector for solid-to-flexible wire
- Also with dual squeeze-to-open version for flexible-to-flexible wire
- Tool-free connection



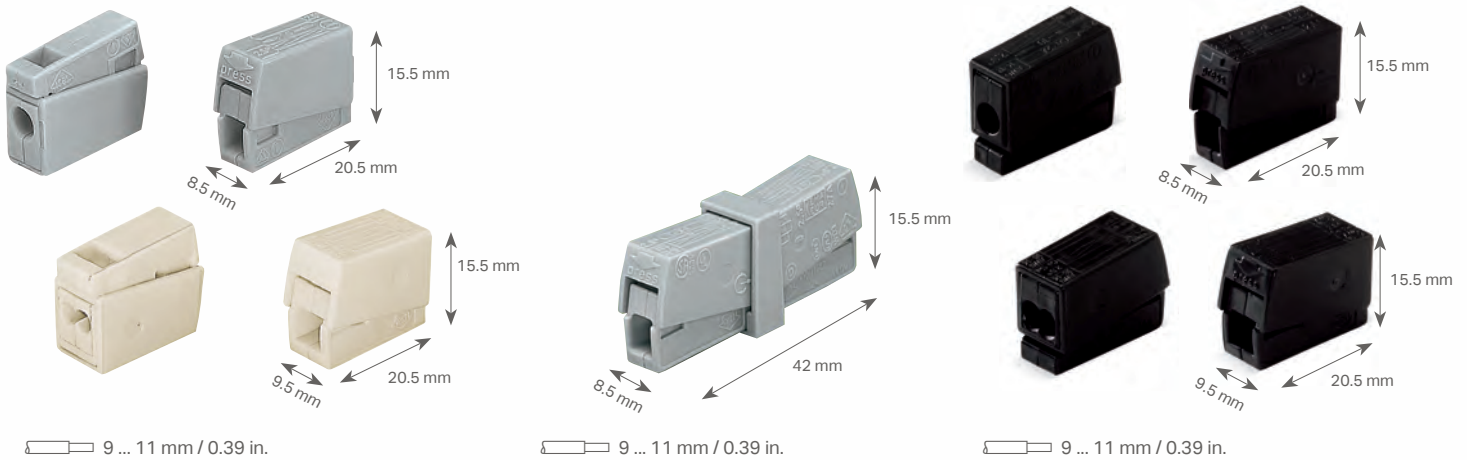

Inline connector with PUSHWIRE® and squeeze-to-open connection		Dual squeeze-to-open connector accepts flexible wire on both sides		Inline connector for increased operating temperature of 120 °C	
Item No.	Pack.-unit pcs	Item No.	Pack.-unit pcs	Item No.	Pack.-unit pcs
● 224-101	100	● 224-201	50	● 224-104	100
○ 224-112 (daisy chain)	100			● 224-114 (daisy chain)	100

## Line Side



**Connection:**  
Insert stripped solid conductor into circular entry and push to stop

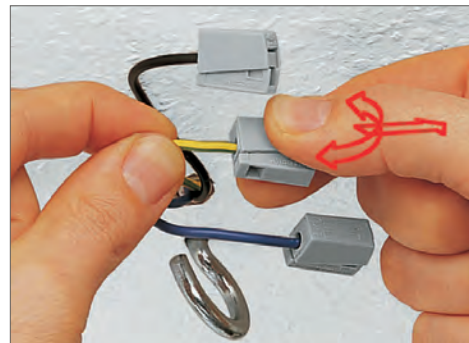

**Removal:**  
Hold wire to be removed and twist and pull the conductor

## Load Side

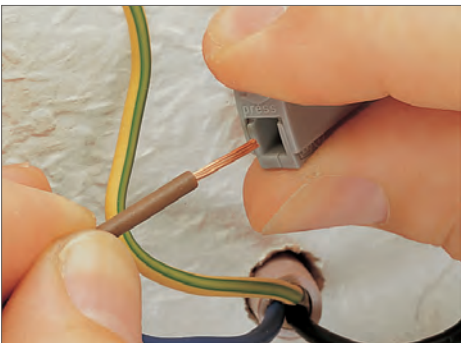

**Connection:**  
Squeeze connector housing and insert stripped conductor into square entry, then release

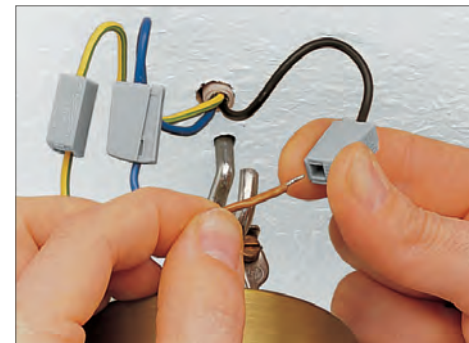

**Removal:**  
Squeeze connector housing and withdraw conductor





# 243 SERIES

## MICRO PUSHWIRE® Connectors for Junction Boxes



### 243 SERIES

- Common up to eight small, solid wires quickly and conveniently
- Gang multiple connectors together with their dovetail features
- Test the circuit through the front-facing test port
- Differentiate circuits with multiple color options

Electrical Data	
Rated voltage	150 V
Nominal current	7 A
Wire Size	
Solid conductor	22 - 18 AWG 
Strip length	5 ... 6 mm / 0.22 in.
Maximum operating temperature	105 °C
Approvals	   

# MICRO PUSHWIRE® Connectors for Junction Boxes

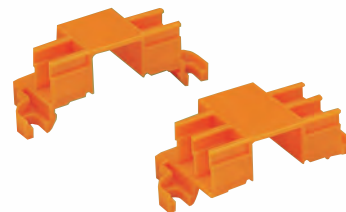
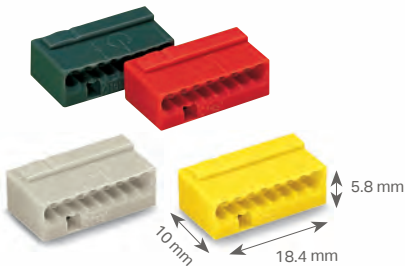
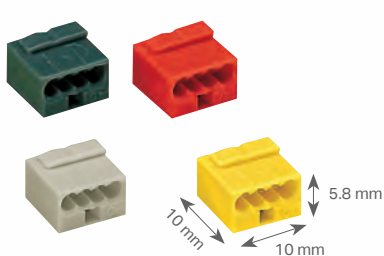

□ 5 ... 6 mm / 0.22 in.

□ 5 ... 6 mm / 0.22 in.

4-conductor connector		8-conductor connector		Mounting carrier for DIN rail or flat surface mounting	
Item No.	Pack.-unit pcs	Item No.	Pack.-unit pcs	Item No.	Pack.-unit pcs
● 243-204	100	● 243-208	50	243-112 (4 connectors)	10
● 243-804	100	● 243-808	50	243-113 (6 connectors)	10
● 243-304	100	● 243-308	50		
● 243-504	100	● 243-508	50		



Assemble modular connectors into ganged connector strips

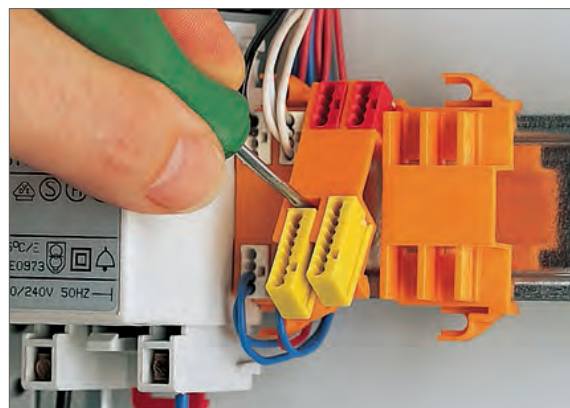

Removing mounting carrier from DIN rail assembly



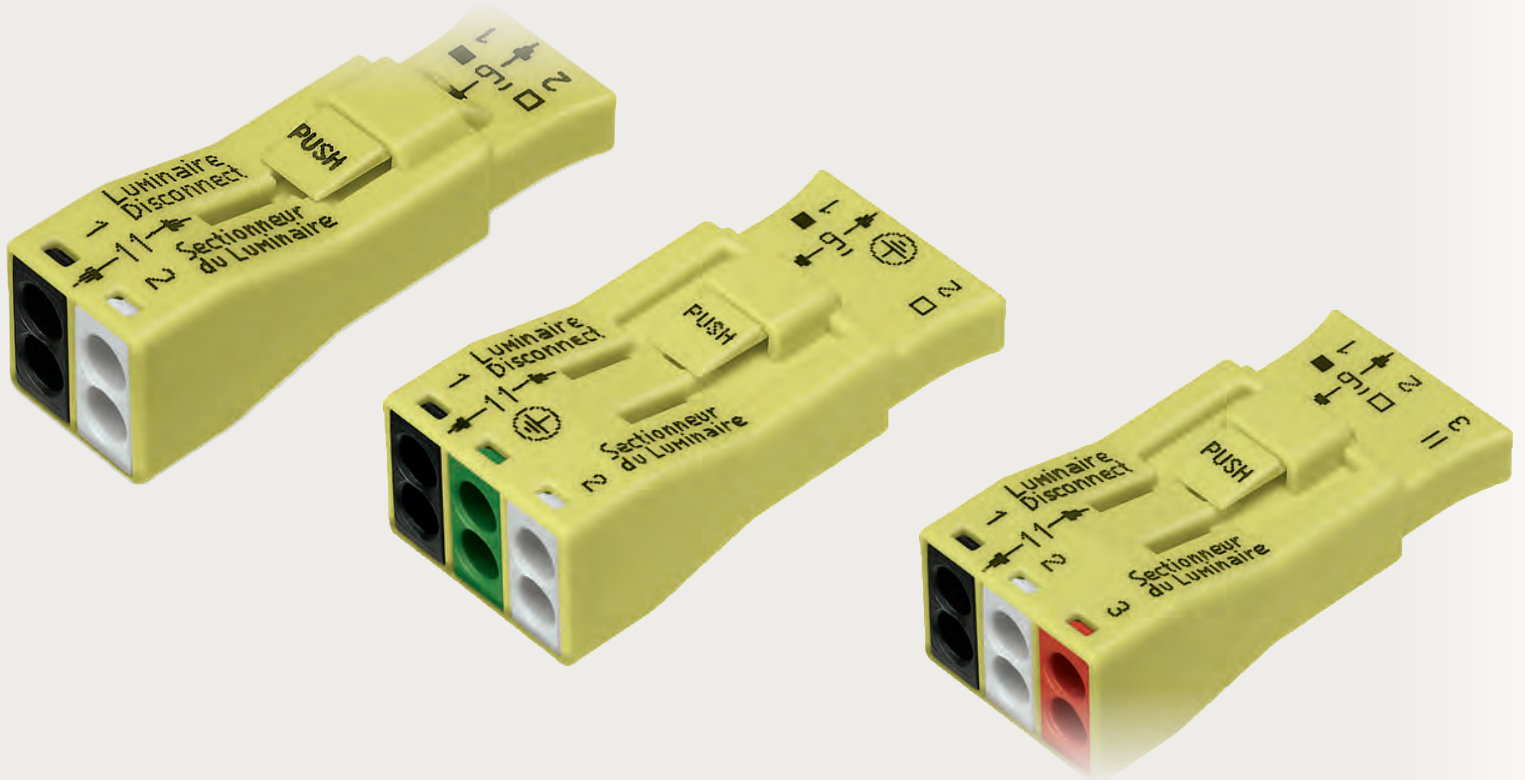

# 873 SERIES LUMI-NUTS®

PUSHWIRE® Connector for Luminaire Disconnect



## 873 SERIES LUMI-NUTS®

- Molded in color coding for circuit wiring
- Two connections per pole on male side for daisy chaining
- 20 A current capacity to support multiple fixture loads
- Two-piece contact construction featuring high grade stainless steel spring (for contact force) and electrolytic copper current bar (for electrical integrity)
- Integrated locking latch – automatic locking with mating of connectors – simple push down to disengage
- UL94 V-0 flame retardant rated housing

Electrical Data		
	Male (plug)	Female (socket)
Rated voltage	600 V	600 V
Nominal current	20 A	6 A
Wire Size		
Solid conductor	18 - 12 AWG 	18 AWG 
Stranded conductor (≤19 strands)	16 - 12 AWG	
Strip length	11 ... 13 mm / 0.47 in.	9 ... 11 mm / 0.47 in.
Maximum operating temperature		105 °C
Approvals	  	

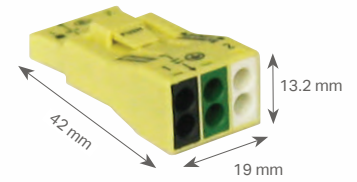
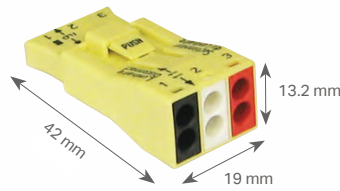
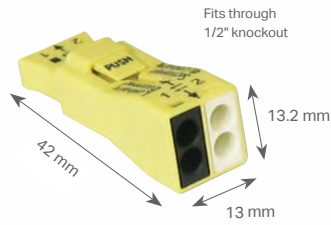

9 ... 11 mm / 0.39 in.  
 11 ... 13 mm / 0.47 in.  
 9 ... 11 mm / 0.39 in.  
 11 ... 13 mm / 0.47 in.  
 9 ... 11 mm / 0.39 in.  
 11 ... 13 mm / 0.47 in.

2-pole connector		3-pole connector for switching and dimming applications		3-pole connector with "make first/break last" ground circuit	
Item No.	Pack.-unit pcs	Item No.	Pack.-unit pcs	Item No.	Pack.-unit pcs
873-902	1=box of 25 pcs	873-903	1=box of 20 pcs	873-953/VE00-0500	500 (bulk)
873-902/PW05-200	1=jar of 200 pcs	873-903/PW05-100	1=jar of 100 pcs		
873-902/VE00-0500	500 (bulk)	873-903/VE00-0500	500 (bulk)		
873-902/VE00-5000	2,500 (bulk)				

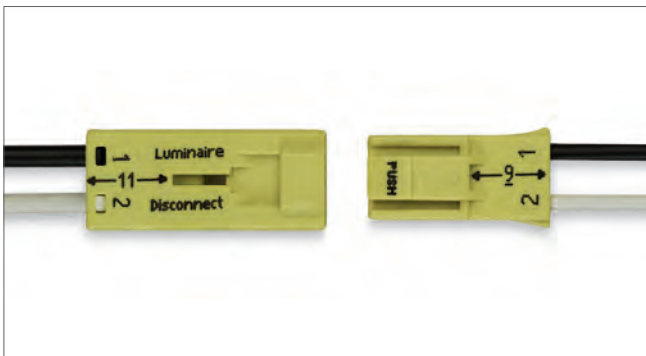

Luminaire disconnect 873-902 (2-pole) in disconnected state. Both plug and socket are touch-proof. Marking details include circuit identification and strip length indication

### APPLICATION NOTE

Touch-proof, 'hot-pluggable' connectors are required for ballast supply wiring in the USA and Canada. When exchanging a ballast:

- 1) The touch-proof connector is disconnected first
- 2) The ballast is replaced
- 3) Power connection is restored by plugging the connection back together. This speeds ballast replacement while enhancing safety by protecting the installer from electrical shock.

873 Series LUMI-NUTS® are approved according to UL2459 and CSA 22.2 for this type of application.









# 862 SERIES

## Terminal Blocks for Chassis Mounting



### 862 SERIES

- Integrated push-button, with molded-in slots accommodates fast and easy wiring of all conductor types – by hand or slotted tip/Phillips screwdriver
- Four conductors/pole allows for flexible wiring or convenient jumpering
- Convenient automatic grounding contact available
- Snap-in mounting feet for fast assembly
- Flexible marking options: standard marking (pre-marked), marker strip or custom marked for large quantity orders
- Built-in test points simplify testing with 2 mm / 0.079 in. diameter test plug

Electrical Data			
Rated voltage	300 V	600 V	600 V <sup>1</sup>
Nominal current	20 A	5 A	20 A
Wire Size			
Solid / stranded conductor	22 - 12 AWG 		
Solid / stranded conductor	20 - 12 AWG 		
Strip length	10 ... 11 mm / 0.41 in.		
Maximum operating temperature	120 °C		
Approvals	      		

<sup>1</sup> 600 V when each wired terminal is surrounded by unused adjacent terminals

<sup>2</sup> Ex versions available - contact factory for part numbers.

# MOUNTING OPTIONS

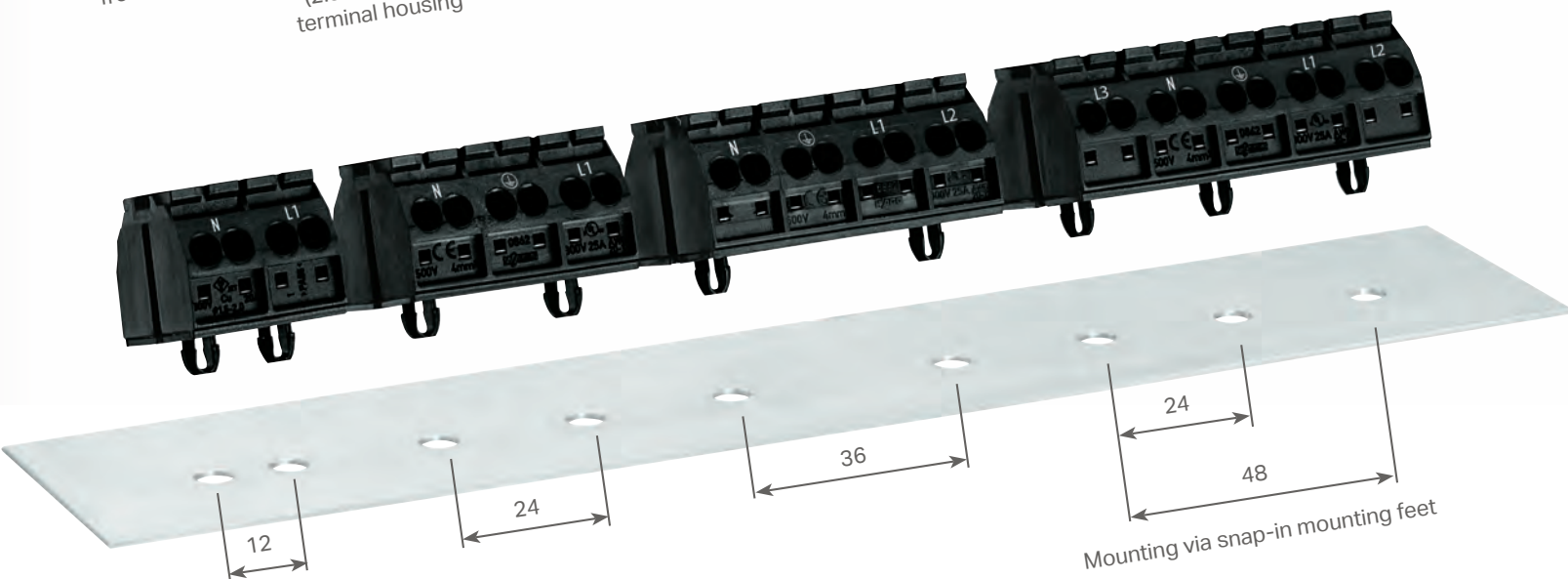
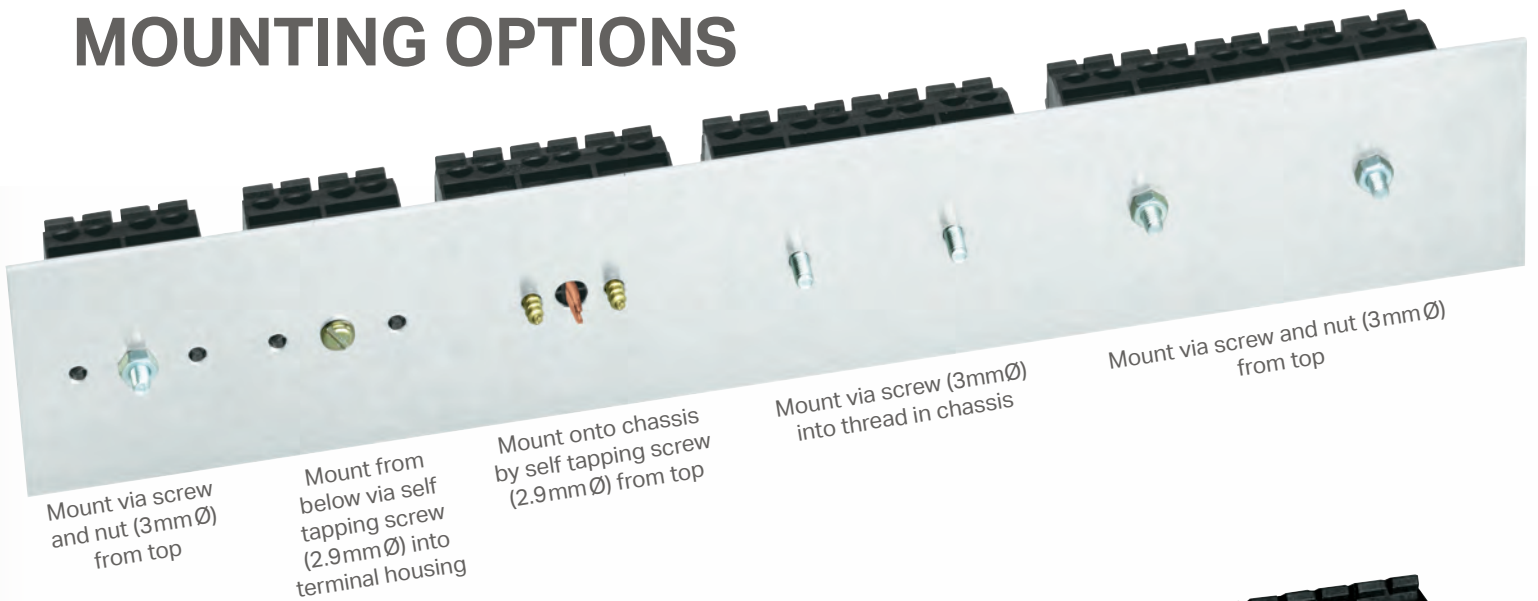

## Dimensions (mm)

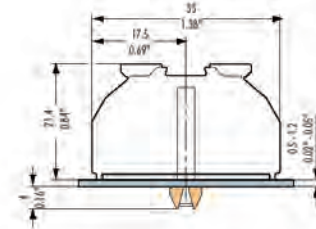
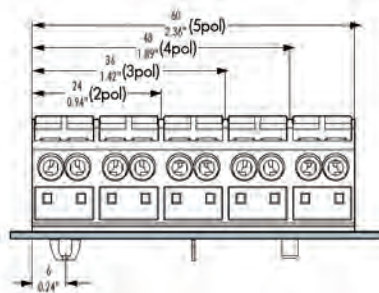
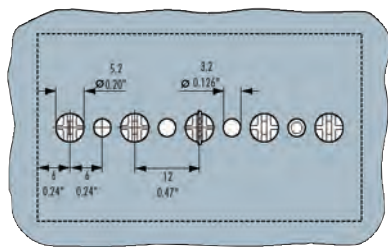

Mounting foot for DIN rail mounting	
Item No.	Pack.-unit pcs
209-120	25

# 862 SERIES TERMINAL BLOCKS

Available in  
black and white

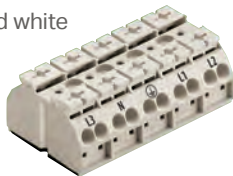

	2 poles/8 connection points			3 poles/12 connection points		
	Item No. black	Item No. white	Pack.-unit pcs	Item No. black	Item No. white	Pack.-unit pcs
for fastening screw (3 mm Ø) or for self tapping screw (2.9) mm Ø from top						
without marking	● 862-552	○ 862-652	500			
L1-N (pre-marked), without ground contact	● 862-1552	○ 862-1652	500			
N-L1 (pre-marked), without ground contact	● 862-2552	○ 862-2652	500			
without marking				● 862-503	○ 862-603	250
PE-N-L1 (pre-marked), without ground contact				● 862-1503	○ 862-1603	250
N-PE-L1 (pre-marked), without ground contact				● 862-2503	○ 862-2603	250
N-PE-L1 (pre-marked), with ground contact				● 862-8503	○ 862-8603	250
PE-N-L1, (pre-marked), with ground contact				● 862-9503	○ 862-9603	250
for self tapping screw 2.9 mm Ø from below						
without marking	● 862-562	○ 862-662	500			
L1-N (pre-marked), without ground contact	● 862-1562	○ 862-1662	500			
N-L1 (pre-marked), without ground contact	● 862-2562	○ 862-2662	500			
1 snap-in foot per pole						
without marking	● 862-532	○ 862-632	500			
L1-N (pre-marked), without ground contact	● 862-1532	○ 862-1632	500			
N-L1 (pre-marked), without ground contact	● 862-2532	○ 862-2632	500			
without marking				● 862-533	○ 862-633	250
PE-N-L1 (pre-marked), without ground contact				● 862-1533	○ 862-1633	250
N-PE-L1 (pre-marked), without ground contact				● 862-2533	○ 862-2633	250
N-PE-L1 (pre-marked), with ground contact				● 862-8533	○ 862-8633	250
PE-N-L1 (pre-marked), with ground contact				● 862-9533	○ 862-9633	250
snap-in feet at pos. 1+3						
without marking				● 862-593	○ 862-693	250
PE-N-L1 (pre-marked), without ground contact				● 862-1593	○ 862-1693	250
N-PE-L1 (pre-marked), without ground contact				● 862-2593	○ 862-2693	250
N-PE-L1 (pre-marked), with ground contact				● 862-8593	○ 862-8693	250
PE-N-L1 (pre-marked), with ground contact				● 862-9593	○ 862-9693	250

## Accessories



Test plug, with cable 500 mm		Marker strip, 7.5 mm wide, on roll, 50 m long		Comb-type jumper bar		Screwdriver	
Item No.	Pack.-unit pcs	Item No.	Pack.-unit pcs	Item No.	Pack.-unit pcs	Item No.	Pack.-unit pcs
● 210-136 (2 mm Ø)	1	○ 709-178	1	862-482	5	210-720	1
● 210-137 (2.3 mm Ø)	50 (5 x 10)	○ 709-177	1				





	4 poles/16 connection points			5 poles/20 connection points		
	Item No. black	Item No. white	Pack.-unit pcs	Item No. black	Item No. white	Pack.-unit pcs
for fastening screw (3 mm Ø) or for self tapping screw (2.9) mm Ø from top						
without marking	● 862-504	○ 862-604	200			
PE-N-L1-L2 (pre-marked), without ground contact	● 862-1504	○ 862-1604	200			
N-PE-L1-L2 (pre-marked), without ground contact	● 862-2504	○ 862-2604	200			
N-PE-L1-L2 (pre-marked), with ground contact	● 862-8504	○ 862-8604	200			
PE-N-L1-L2 (pre-marked), with ground contact	● 862-9504	○ 862-9604	200			
without marking				● 862-505	○ 862-605	200
PE-N-L1-L2-L3 (pre-marked), without ground contact				● 862-1505	○ 862-1605	200
L3-N-PE-L1-L2 (pre-marked), without ground contact				● 862-2505	○ 862-2605	200
L3-N-PE-L1-L2 (pre-marked), with ground contact				● 862-8505	○ 862-8605	200
PE-N-L1-L2-L3 (pre-marked), with ground contact				● 862-9505	○ 862-9605	200
1 snap-in foot per pole						
without marking	● 862-534	○ 862-634	200			
PE-N-L1-L2 (pre-marked), without ground contact	● 862-1534	○ 862-1634	200			
N-PE-L1-L2 (pre-marked), without ground contact	● 862-2534	○ 862-2634	200			
N-PE-L1-L2 (pre-marked), with ground contact	● 862-8534	○ 862-8634	200			
PE-N-L1-L2 (pre-marked), with ground contact	● 862-9534	○ 862-9634	200			
snap-in feet at pos. 1 + 4						
without marking	● 862-594	○ 862-694	200			
PE-N-L1-L2 (pre-marked), without ground contact	● 862-1594	○ 862-1694	200			
N-PE-L1-L2 (pre-marked), without ground contact	● 862-2594	○ 862-2694	200			
N-PE-L1-L2 (pre-marked), with ground contact	● 862-8594	○ 862-8694	200			
PE-N-L1-L2 (pre-marked), with ground contact	● 862-9594	○ 862-9694	200			
snap-in feet at pos. 2 + 4						
without marking				● 862-525	○ 862-625	200
PE-N-L1-L2-L3 (pre-marked), without ground contact				● 862-1525	○ 862-1625	200
L3-N-PE-L1-L2 (pre-marked), without ground contact				● 862-2525	○ 862-2625	200
L3-N-PE-L1-L2 (pre-marked), with ground contact				● 862-8525	○ 862-8625	200
PE-N-L1-L2-L3 (pre-marked), with ground contact				● 862-9525	○ 862-9625	200
snap-in feet at pos. 1 + 3 + 5						
without marking				● 862-515	○ 862-615	200
PE-N-L1-L2-L3 (pre-marked), without ground contact				● 862-1515	○ 862-1615	200
L3-N-PE-L1-L2 (pre-marked), without ground contact				● 862-2515	○ 862-2615	200
L3-N-PE-L1-L2 (pre-marked), with ground contact				● 862-8515	○ 862-8615	200
PE-N-L1-L2-L3 (pre-marked), with ground contact				● 862-9515	○ 862-9615	200

Versions available with ATEX and IECEx — contact factory for part numbers.

# ACCESSORIES & OPERATING TOOLS

Convenient and Fast

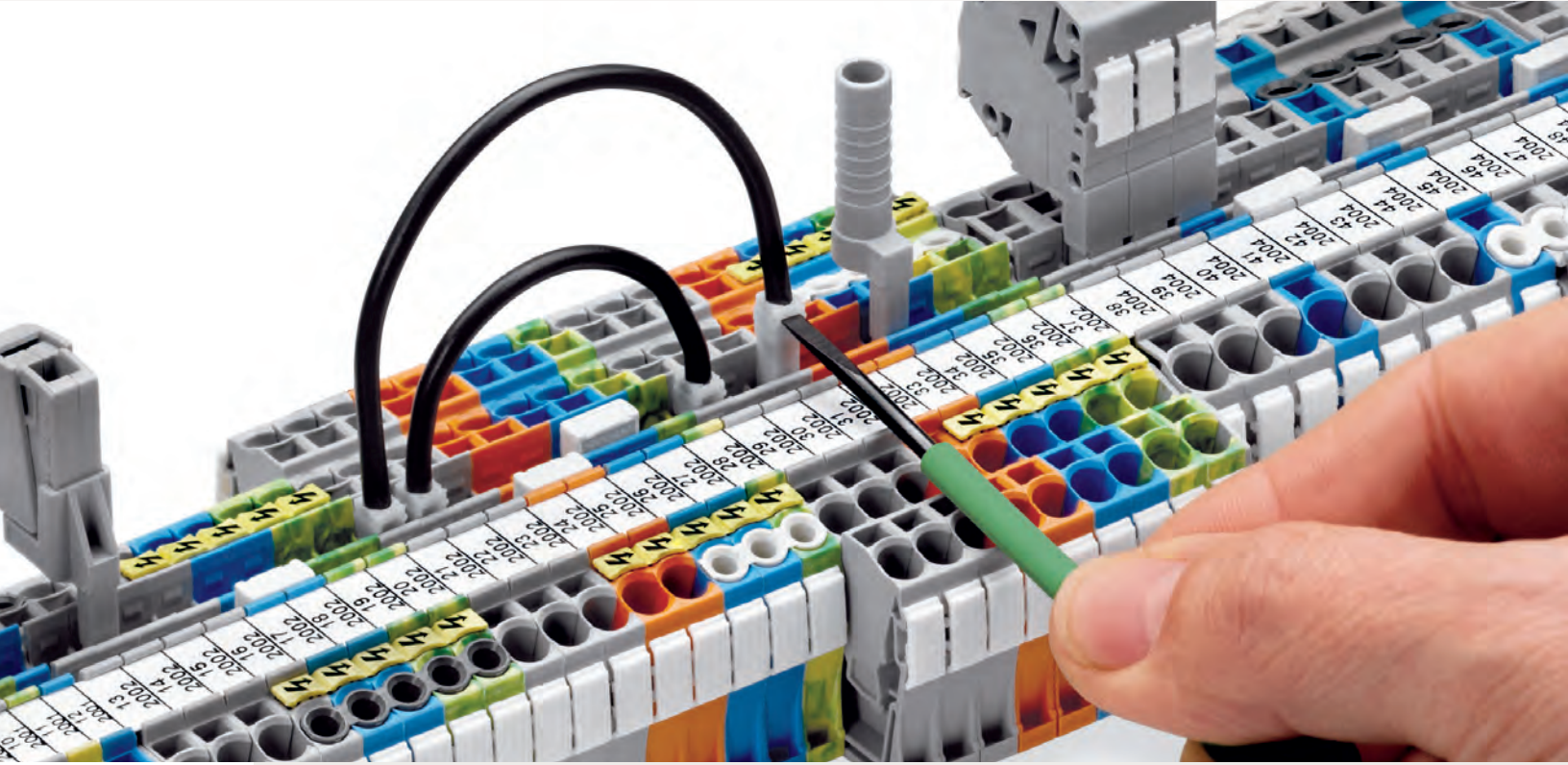

## ACCESSORIES

WAGO offers a complete range of accessory products to make installation and testing quick and easy:

- Operating tools for actuating the CAGE CLAMP®
- Test devices and accessories to reliably detect voltage
- Convenient wire cutting and stripping tools
- Ferrules and crimping tools to install them

### Stripping and Cutting Tools

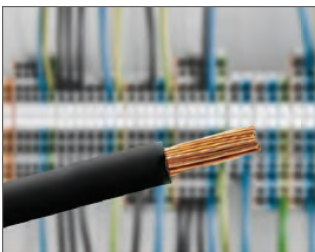

### Ferrules



### Crimping Tools



### Test and Measurement Devices



# Screwdrivers and Banana Plugs

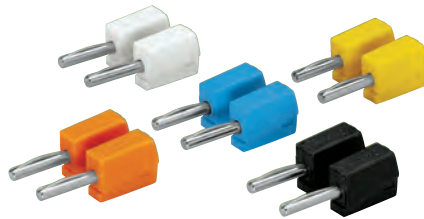

Screwdriver		Banana plugs, for sockets Ø 4 mm 28 - 14 AWG	
Item No.	Pack.-unit pcs	Item No.	Pack.-unit pcs
210-719 (2.5 x 0.4 mm blade)	1	215-111 (mixed colors)	50
210-720 (3.5 x 0.5 mm blade)	1	● 215-211	50
210-721 (5.5 x 0.8 mm blade)	1	● 215-212	50
210-722 (set of all 3)	1	● 215-311	50
		● 215-411	50
		● 215-511	50
		● 215-711	50
		● 215-811	50
		● 215-911	50



Set of screwdrivers in a box



Connection of conductors via banana plugs:  
Press button fully and insert stripped  
conductor into square entry and release

# Wire Stripping and Cutting Tools



Quickstrip vario wire stripper with integrated wire cutter 32 - 6 AWG		Replacement blade cassettes for Quickstrip tool		Stripping pliers for sensor wires Ø .13" ... .17"	
Item No.	Pack.-unit pcs	Item No.	Pack.-unit pcs	Item No.	Pack.-unit pcs
206-1125	1	206-1126 (Standard blade for Quickstrip)	1	206-1481	1
		206-1127 (V blade/PTFE wire for Quickstrip)	1		
		206-1128 (Blade set for Quickstrip, oval blade)	1		



Stripping pliers for control wires Ø .17" ... .28"		Tool kit Includes Quickstrip 10 and Variocrimp 4	
Item No.	Pack.-unit pcs	Item No.	Pack.-unit pcs
206-1482	1	60348435	1



Automatic stripping for control and sensor wires



Convenient, stackable kit design

# Cable Stripping and Cutting Tools



Cable cutter for up to 2 AWG conductors		Cable knife with intelligent bracket change system Ø .31" ... 1.10"		Cable knife kit includes all cable brackets in an L-boxx mini Ø .16" ... 2.75"	
Item No.	Pack.-unit pcs	Item No.	Pack.-unit pcs	Item No.	Pack.-unit pcs
206-118	1	206-1403	1	206-1400	1



Cable stripper; in-socket Ø .31" ... .51"		Cable stripper; universal Ø .31" ... .51" From 8 mm ... 13 mm		Cable stripper; data Ø .18" ... .40" From 4.5 mm ... 10 mm	
Item No.	Pack.-unit pcs	Item No.	Pack.-unit pcs	Item No.	Pack.-unit pcs
206-1441	1	206-1442	1	206-1451	1



Cutting of cable



Spiral cut cable stripper



Intelligent bracket change system

# Ferrules and Crimping Tools

## Insulated Ferrules

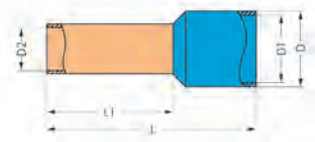

## Uninsulated Ferrules

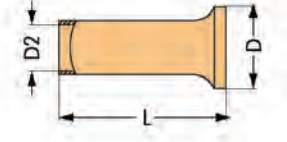

Insulated Ferrules									
Sleeve for mm <sup>2</sup>	AWG	Stripped length (mm)	L (mm)	L1 (mm)	D (mm)	D1 (mm)	D2 (mm)	Item No.	Pack.-unit pcs
0.5	20	12.0	16.0	10.0	3.1	2.6	1.0	○ 216-241	1,000
0.75	18	12.0	16.0	10.0	3.3	2.8	1.2	● 216-242	1,000
1.0	18	12.0	16.0	10.0	3.5	3.0	1.4	● 216-243	1,000
1.5	16	12.0	16.0	10.0	4.0	3.5	1.7	● 216-244	1,000

Uninsulated Ferrules								
Sleeve for mm <sup>2</sup>	AWG	Stripped length (mm)	L (mm)	D (mm)	D2 (mm)	Item No.	Pack.-unit pcs	
0.5	20	10.0	10.0	2.1	1.0	216-141	1,000	
0.75	18	10.0	10.0	2.3	1.2	216-142	1,000	
1.0	18	10.0	10.0	2.5	1.4	216-143	1,000	
1.5	16	10.0	10.0	2.8	1.7	216-144	1,000	

## Crimping Tools



Variocrimp 4 For insulated and uninsulated ferrules, 24 - 12 AWG		Variocrimp 16 For insulated and uninsulated ferrules, 10 - 6 AWG		Ferrule kit Includes 1000 pcs of 20 AWG (216-241), 1000 pcs of 18 AWG (216-242), 1000 pcs of 18 AWG (216-243), 500 pcs of 16 AWG (216- 264), 500 pcs of 14 AWG (216-266), and 400 pcs of 12 AWG (216-267)	
Item No.	Pack.-unit pcs	Item No.	Pack.-unit pcs	Item No.	Pack.-unit pcs
206-1204	1	206-1216	1	60348433	1

# Test and Measurement Devices



Testboy with integrated flashlight		Digital clamp-on multi-tester		Multi-tester digital multimeter with contact-less voltage tester	
Item No.	Pack.-unit pcs	Item No.	Pack.-unit pcs	Item No.	Pack.-unit pcs
206-804	1	206-816	1	206-810	1
<ul style="list-style-type: none"> <li>Voltage range: 12 - 1000 VAC</li> </ul>		<ul style="list-style-type: none"> <li>DC and AC current voltage up to 600 A/600 V</li> <li>True RMS and min./max. value</li> <li>Measurement resistance up to 60 MΩ, capacitance measurement</li> <li>Acoustical continuity test</li> <li>Diode test, Data hold function</li> <li>Large LCD with backlight</li> <li>LED measuring point lighting</li> <li>Includes batteries, measurement leads and carrying bag</li> </ul>		<ul style="list-style-type: none"> <li>Measuring range: AC/DC 600 VAC/VDC 10 A</li> <li>Resistance measurement: up to 20 MΩ</li> <li>Includes carrying case</li> </ul>	



Profi LED+ voltage tester LED display; 2 poles; removable test probes		Profi LED+ voltage tester LCD display; 2 poles; removable test probes	
Item No.	Pack.-unit pcs	Item No.	Pack.-unit pcs
206-706	1	206-707	1
<ul style="list-style-type: none"> <li>DC Voltage Range 6-1400 V</li> <li>AC Voltage Range 6-1000 V</li> <li>Single-pole phase search</li> <li>Two-pole phase sequence testing</li> <li>Optical and acoustical continuity testing</li> <li>Auto power-on/off function</li> <li>Includes batteries</li> </ul>		<ul style="list-style-type: none"> <li>DC Voltage 4-1400 V</li> <li>AC Voltage 3-1000 V</li> <li>Single-pole phase search</li> <li>Two-pole phase sequence testing</li> <li>Continuity and resistance testing</li> <li>Illuminated LCD display</li> <li>Includes batteries</li> </ul>	

WAGO Corporation  
N120 W19129 Freistadt Road  
Germantown, Wisconsin 53022  
Telephone: 800 / DIN-Rail (346-7245)  
Fax: 262 / 255-3232  
info.us@wago.com  
www.wago.us

WAGO Canada Inc.  
1550 Yorkton Court, Unit 1  
Burlington, ON  
L7P 5B7  
Telephone: 888 / WAGO 221 (924-6221)  
info.ca@wago.com  
www.wago.ca

WAGO SA DE CV  
Carretera estatal 431 Km. 2+200. Lote 99 6  
Parque Industrial Tecnológico Innovación Querétaro  
El Marques, Qro. 76246  
Lada sin Costo: 01 800 288 WAGO (288-9246)  
Telefono: 422 / 221-5946  
info.mx@wago.com  
www.wago.mx

WAGO is a registered trademark of WAGO Verwaltungsgesellschaft mbH.

"Copyright – WAGO Kontakttechnik GmbH & Co. KG – all rights reserved. The content and structure of the WAGO Websites, catalogs, videos, and other WAGO media are subject to copyright. The dissemination or changing of the content of these pages and videos is not permitted. Furthermore, the content may neither be copied nor made available to third parties for commercial purposes. Also subject to copyright are the images and videos that were made available to WAGO Kontakttechnik GmbH & Co. KG by third parties."