

GT3 Series Multi-function Timers

Wide Variety Including OFF Delay and Star-Delta Types

Universal AC power voltage 100 to 240V AC
 Solid-state CMOS circuitry ensures high accuracy
 Easy-to-view operation indicator
 DIN 48mm square panel mount adapter for snap mounting
 Complies with safety standards. UL/c-UL listed.
 Complies with EN standard



[Multi-mode Type]

Instantaneous operation at zero setting
 Multi-mode, and universal AC power voltage cover 96 types by one timer



Type List

Multi-Mode Type

For details, see pages 1067 to 1072.

Operation Mode		Type	Contact	Time Range	Output	Operating Voltage	Type No.
On Delay Interval ON Cycle OFF Cycle ON		GT3A-1	Delayed SPDT	0.1 sec to 180 hours	240V AC, 3A 120V AC/ 30V DC, 5A	100 to 240V AC	GT3A-1AF20
		GT3A-2	Delayed SPDT + Instantaneous SPDT			100 to 240V AC	GT3A-2AF20
		GT3A-3	Delayed DPDT			24V AC/24V DC	GT3A-2AD24
ON Delay Cycle Signal ON/OFF Delay Signal OFF Delay	With Input	GT3A-4	Delayed DPDT (11P)	0.1 sec to 180 hours	240V AC/ 24V DC, 5A	100 to 240V AC	GT3A-4AF20
						24V AC/24V DC	GT3A-4AD24
Interval ON One Shot Cycle Signal ON/OFF Delay Signal OFF Delay	With Input	GT3A-5	Delayed DPDT (11P)	0.1 sec to 180 hours	240V AC/ 24V DC, 5A	100 to 240V AC	GT3A-5AF20
		GT3A-6				24V AC/24V DC	GT3A-5AD24
One Shot One Shot ON Delay One Shot Signal ON/OFF Delay	With Input	GT3A-6	Delayed DPDT (11P)	0.1 sec to 180 hours	240V AC/ 24V DC, 5A	100 to 240V AC	GT3A-6AF20
						24V AC/24V DC	GT3A-6AD24

OFF Delay Type

For details, see pages 1073 to 1074.

Operation Mode		Type	Contact	Time Range	Output	Operating Voltage	Type No.
Power OFF Delay	With Reset Input	GT3F-1	Delayed SPDT	0.1 sec to 600 sec	250V AC/ 30V DC, 5A	100 to 240V AC	GT3F-1AF20
	Without Reset Input	GT3F-2	Delayed DPDT			24V AC/24V DC	GT3F-1AD24
						100 to 240V AC	GT3F-2AF20
						24V AC/24V DC	GT3F-2AD24

Star-Delta Type

For details, see pages 1075 to 1076.

Operation Mode	Type	Contact	Time Range	Output	Operating Voltage	Type No.
Star-Delta	GT3S-1	Delayed Star: SPST-NO Delta: SPST-NO	Star: 0.05 to 100 sec Star-Delta: 0.05 sec	250V AC/ 30V DC, 5A	100 to 240V AC	GT3S-1AF20
	GT3S-2	Delayed Star: SPST-NO Delta: SPST-NO Instantaneous: SPST-NO	0.1 sec 0.25 sec 0.5 sec			GT3S-2AF20

Twin-Timer Type

For details, see pages 1077 to 1078.

Operation Mode	Type	Contact	Time Range	Output	Operating Voltage	Type No.
Serial Activation Coarse/Fine Adjust- ment Setting Instantaneous Cycle Cycle Cycle Inversion Interval ON Interval ON Delay Serial Interval ON	GT3W-A	Delayed SPDT + Delayed SPDT	T1: 0.1 sec to 6 hours T2: 0.1 sec to 6 hours	240V AC, 3A	100 to 240V AC	GT3W-A11AF20N
					24V AC/24V DC	GT3W-A11AD24N
			T1: 0.1 sec to 6 hours T2: 0.1 sec to 300 hours	120V AC/ 30V DC, 5A	100 to 240V AC	GT3W-A13AF20N
					24V AC/24V DC	GT3W-A13AD24N
			T1: 0.1 sec to 300 hours T2: 0.1 sec to 6 hours		100 to 240V AC	GT3W-A31AF20N
					24V AC/24V DC	GT3W-A31AD24N
			T1: 0.1 sec to 300 hours T2: 0.1 sec to 300 hours		100 to 240V AC	GT3W-A33AF20N
					24V AC/24V DC	GT3W-A33AD24N

GT3A-1, -2, -3

Four Selectable Operation Modes in One Timer: ON Delay, Interval ON, Cycle, Cycle ON

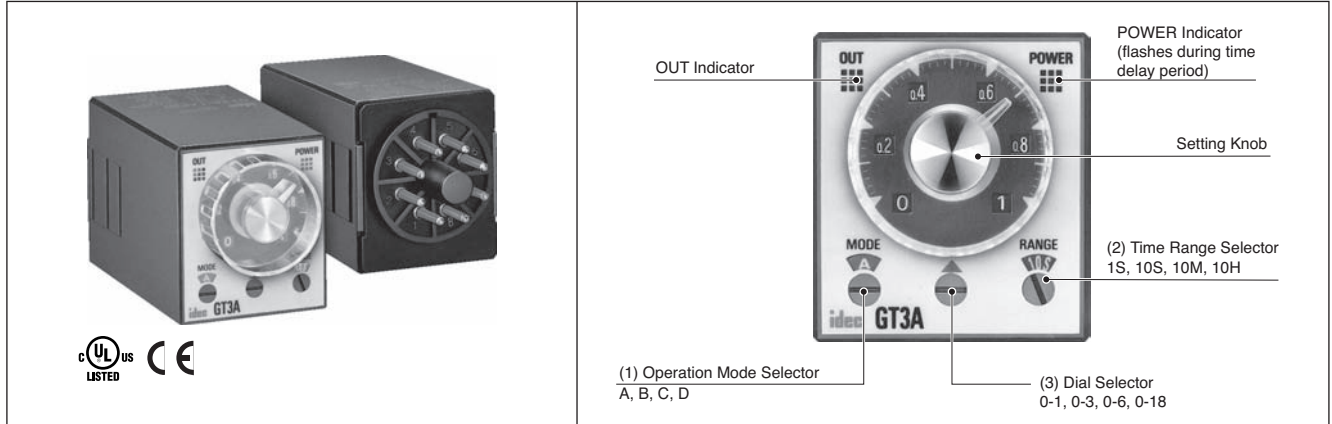

Type List

(1) Operation Mode	Rated Voltage	Time Ranges	Output	Contact	Type No.
A: ON Delay B: Interval ON C: Cycle OFF D: Cycle ON	100 to 240V AC	0.1 sec to 180 hours See Time Ranges for details.	240V AC, 3A 120V AC/30V DC, 5A (resistive load)	Delayed SPDT	GT3A-1AF20
	100 to 240V AC				Delayed SPDT + Instantaneous SPDT
	24V AC/24V DC		240V AC/24V DC, 5A (resistive load)	Delayed DPDT	GT3A-2AD24
	100 to 240V AC				GT3A-3AF20
	24V AC/24V DC			GT3A-3AD24	

Time Ranges

(2) Range \ (3) Dial	0 - 1	0 - 3	0 - 6	0 - 18
1S	0.1 sec to 1 sec	0.1 sec to 3 sec	0.1 sec to 6 sec	0.2 sec to 18 sec
10S	0.1 sec to 10 sec	0.3 sec to 30 sec	0.6 sec to 60 sec	1.8 sec to 180 sec
10M	6 sec to 10 min	18 sec to 30 min	36 sec to 60 min	108 sec to 180 min
10H	6 min to 10 hours	18 min to 30 hours	36 min to 60 hours	108 min to 180 hours

Contact Ratings

Type	GT3A-1, GT3A-2	GT3A-3
Rated Load	240V AC, 3A (resistive load) 120V AC/30V DC, 5A (resistive load)	240V AC/24V DC, 5A (resistive load)
Maximum Switching Power	AC: 960VA DC: 120W	AC: 1200VA DC: 120W
Maximum Switching Voltage	250V AC/150V DC	
Maximum Switching Current	5A	
Maximum Switching Frequency	1800 operations/hour	
Minimum Applicable Load	5V DC, 10 mA (reference value)	
External Protection Element	Fuse 250V, 5A	
Life	Electrical	100,000 operations minimum (rated load)
	Mechanical	20,000,000 operations minimum

General Specifications

Type	GT3A-1	GT3A-2	GT3A-3		
Operation System	Solid-state CMOS circuitry				
Operation Type	Multi-Mode				
Time Range	0.1 sec to 180 hours				
Pollution Degree	2 (IEC60664-1)				
Overvoltage Category	III (IEC60664-1)				
Rated Voltage	AF20	100 to 240V AC (50/60Hz)			
	AD24	24V AC (50/60Hz)/24V DC			
Voltage Range	AF20	85 to 264V AC (50/60Hz)			
	AD24	20.4 to 26.4V AC (50/60Hz)/21.6 to 26.4V DC			
Reset Voltage	Rated voltage 10% minimum				
Operating Temperature	-10 to +50°C (no freezing)				
Storage/Transportation Temperature	-30 to +70°C (no freezing)				
Operating Humidity	35 to 85% RH (no condensation)				
Altitude	0 to 2000m (operation) 0 to 3000m (transportation)				
Reset Time	60 ms maximum				
Repeat Error	±0.2%, ±10 ms maximum (Note)				
Voltage Error	±0.2%, ±10 ms maximum (Note)				
Temperature Error	±0.2%, ±10 ms maximum (Note)				
Setting Error	±10% maximum				
Insulation Resistance	100 MΩ minimum (500V DC megger)				
Dielectric Strength	Between power and output terminals: 2000V AC, 1 minute				
	Between contacts of different poles: 2000V AC, 1 minute				
	Between contacts of the same pole: 750V AC, 1 minute (GT3A-1, 2) 1000V AC, 1 minute (GT3A-3)				
Vibration Resistance	10 to 55 Hz, amplitude 0.75 mm, 2 hours each in 3 directions				
Shock Resistance	Operating extremes: 98 m/s ² , Damage limits: 490 m/s ² , 3 shocks each in 6 directions				
Degree of Protection	IP40 (timer), IP20 (socket) (IEC60529)				
Power Consumption (approx.)	AF20	100V AC 60Hz	2.9VA	2.5VA	2.2VA
		200V AC 60Hz	4.7VA	4.3VA	4.0VA
	AD24 (AC/DC)	1.3VA/0.5W	1.6VA/0.8W	1.8VA/0.7W	
Dimensions	40H 36W	72.2D mm			
Weight (approx.)	63g	73g	79g		

Note: The largest value becomes the error against a preset value depending on the time range.

GT3 Series [Multi-Mode Type]

Operation Chart

		Operation Chart																																																							
Type No.		GT3A-1 <input type="checkbox"/>	GT3A-2 <input type="checkbox"/>	GT3A-3 <input type="checkbox"/>																																																					
Contact		Delayed SPDT	Delayed SPDT + Instantaneous SPDT	Delayed DPDT																																																					
Internal Connection																																																									
	Operation Mode Selection																																																								
On Delay	MODE A Set timer for desired delay, apply power to coil. Contacts transfer after preset time has elapsed, and remain in transferred position until timer is reset. Reset occurs with removal of power.	<table border="1"> <thead> <tr> <th>Item</th> <th>Terminal No.</th> <th>Operation</th> </tr> </thead> <tbody> <tr> <td>Power</td> <td>2-7</td> <td></td> </tr> <tr> <td rowspan="2">Delayed Contact</td> <td>5-8 (NC)</td> <td></td> </tr> <tr> <td>6-8 (NO)</td> <td></td> </tr> <tr> <td rowspan="2">Indicator</td> <td>POWER</td> <td></td> </tr> <tr> <td>OUT</td> <td></td> </tr> </tbody> </table>	Item	Terminal No.	Operation	Power	2-7		Delayed Contact	5-8 (NC)		6-8 (NO)		Indicator	POWER		OUT		<table border="1"> <thead> <tr> <th>Item</th> <th>Terminal No.</th> <th>Operation</th> </tr> </thead> <tbody> <tr> <td>Power</td> <td>2-7</td> <td></td> </tr> <tr> <td rowspan="2">Delayed Contact</td> <td>5-8 (NC)</td> <td></td> </tr> <tr> <td>6-8 (NO)</td> <td></td> </tr> <tr> <td rowspan="2">Instantaneous Contact</td> <td>4-1 (NC)</td> <td></td> </tr> <tr> <td>3-1 (NO)</td> <td></td> </tr> <tr> <td rowspan="2">Indicator</td> <td>POWER</td> <td></td> </tr> <tr> <td>OUT</td> <td></td> </tr> </tbody> </table>	Item	Terminal No.	Operation	Power	2-7		Delayed Contact	5-8 (NC)		6-8 (NO)		Instantaneous Contact	4-1 (NC)		3-1 (NO)		Indicator	POWER		OUT		<table border="1"> <thead> <tr> <th>Item</th> <th>Terminal No.</th> <th>Operation</th> </tr> </thead> <tbody> <tr> <td>Power</td> <td>2-7</td> <td></td> </tr> <tr> <td rowspan="2">Delayed Contact</td> <td>5-8,4-1 (NC)</td> <td></td> </tr> <tr> <td>6-8,3-1 (NO)</td> <td></td> </tr> <tr> <td rowspan="2">Indicator</td> <td>POWER</td> <td></td> </tr> <tr> <td>OUT</td> <td></td> </tr> </tbody> </table>	Item	Terminal No.	Operation	Power	2-7		Delayed Contact	5-8,4-1 (NC)		6-8,3-1 (NO)		Indicator	POWER		OUT	
		Item	Terminal No.	Operation																																																					
		Power	2-7																																																						
		Delayed Contact	5-8 (NC)																																																						
			6-8 (NO)																																																						
Indicator	POWER																																																								
	OUT																																																								
Item	Terminal No.	Operation																																																							
Power	2-7																																																								
Delayed Contact	5-8 (NC)																																																								
	6-8 (NO)																																																								
Instantaneous Contact	4-1 (NC)																																																								
	3-1 (NO)																																																								
Indicator	POWER																																																								
	OUT																																																								
Item	Terminal No.	Operation																																																							
Power	2-7																																																								
Delayed Contact	5-8,4-1 (NC)																																																								
	6-8,3-1 (NO)																																																								
Indicator	POWER																																																								
	OUT																																																								
Interval ON	MODE B Set timer for desired delay, apply power to coil. Contacts transfer immediately, and return to original position after preset time has elapsed. Reset occurs with removal of power.	<table border="1"> <thead> <tr> <th>Item</th> <th>Terminal No.</th> <th>Operation</th> </tr> </thead> <tbody> <tr> <td>Power</td> <td>2-7</td> <td></td> </tr> <tr> <td rowspan="2">Delayed Contact</td> <td>5-8 (NC)</td> <td></td> </tr> <tr> <td>6-8 (NO)</td> <td></td> </tr> <tr> <td rowspan="2">Indicator</td> <td>POWER</td> <td></td> </tr> <tr> <td>OUT</td> <td></td> </tr> </tbody> </table>	Item	Terminal No.	Operation	Power	2-7		Delayed Contact	5-8 (NC)		6-8 (NO)		Indicator	POWER		OUT		<table border="1"> <thead> <tr> <th>Item</th> <th>Terminal No.</th> <th>Operation</th> </tr> </thead> <tbody> <tr> <td>Power</td> <td>2-7</td> <td></td> </tr> <tr> <td rowspan="2">Delayed Contact</td> <td>5-8 (NC)</td> <td></td> </tr> <tr> <td>6-8 (NO)</td> <td></td> </tr> <tr> <td rowspan="2">Instantaneous Contact</td> <td>4-1 (NC)</td> <td></td> </tr> <tr> <td>3-1 (NO)</td> <td></td> </tr> <tr> <td rowspan="2">Indicator</td> <td>POWER</td> <td></td> </tr> <tr> <td>OUT</td> <td></td> </tr> </tbody> </table>	Item	Terminal No.	Operation	Power	2-7		Delayed Contact	5-8 (NC)		6-8 (NO)		Instantaneous Contact	4-1 (NC)		3-1 (NO)		Indicator	POWER		OUT		<table border="1"> <thead> <tr> <th>Item</th> <th>Terminal No.</th> <th>Operation</th> </tr> </thead> <tbody> <tr> <td>Power</td> <td>2-7</td> <td></td> </tr> <tr> <td rowspan="2">Delayed Contact</td> <td>5-8,4-1 (NC)</td> <td></td> </tr> <tr> <td>6-8,3-1 (NO)</td> <td></td> </tr> <tr> <td rowspan="2">Indicator</td> <td>POWER</td> <td></td> </tr> <tr> <td>OUT</td> <td></td> </tr> </tbody> </table>	Item	Terminal No.	Operation	Power	2-7		Delayed Contact	5-8,4-1 (NC)		6-8,3-1 (NO)		Indicator	POWER		OUT	
		Item	Terminal No.	Operation																																																					
		Power	2-7																																																						
		Delayed Contact	5-8 (NC)																																																						
			6-8 (NO)																																																						
Indicator	POWER																																																								
	OUT																																																								
Item	Terminal No.	Operation																																																							
Power	2-7																																																								
Delayed Contact	5-8 (NC)																																																								
	6-8 (NO)																																																								
Instantaneous Contact	4-1 (NC)																																																								
	3-1 (NO)																																																								
Indicator	POWER																																																								
	OUT																																																								
Item	Terminal No.	Operation																																																							
Power	2-7																																																								
Delayed Contact	5-8,4-1 (NC)																																																								
	6-8,3-1 (NO)																																																								
Indicator	POWER																																																								
	OUT																																																								
Cycle OFF (OFF start)	MODE C Set timer for desired delay, apply power to coil. First transfer of contacts occurs after preset delay has elapsed, after the next elapse of preset delay contacts return to original position. The timer now cycles between on and off as long as power is applied. The ratio is 1:1. Time Off = Time On	<table border="1"> <thead> <tr> <th>Item</th> <th>Terminal No.</th> <th>Operation</th> </tr> </thead> <tbody> <tr> <td>Power</td> <td>2-7</td> <td></td> </tr> <tr> <td rowspan="2">Delayed Contact</td> <td>5-8 (NC)</td> <td></td> </tr> <tr> <td>6-8 (NO)</td> <td></td> </tr> <tr> <td rowspan="2">Indicator</td> <td>POWER</td> <td></td> </tr> <tr> <td>OUT</td> <td></td> </tr> </tbody> </table>	Item	Terminal No.	Operation	Power	2-7		Delayed Contact	5-8 (NC)		6-8 (NO)		Indicator	POWER		OUT		<table border="1"> <thead> <tr> <th>Item</th> <th>Terminal No.</th> <th>Operation</th> </tr> </thead> <tbody> <tr> <td>Power</td> <td>2-7</td> <td></td> </tr> <tr> <td rowspan="2">Delayed Contact</td> <td>5-8 (NC)</td> <td></td> </tr> <tr> <td>6-8 (NO)</td> <td></td> </tr> <tr> <td rowspan="2">Instantaneous Contact</td> <td>4-1 (NC)</td> <td></td> </tr> <tr> <td>3-1 (NO)</td> <td></td> </tr> <tr> <td rowspan="2">Indicator</td> <td>POWER</td> <td></td> </tr> <tr> <td>OUT</td> <td></td> </tr> </tbody> </table>	Item	Terminal No.	Operation	Power	2-7		Delayed Contact	5-8 (NC)		6-8 (NO)		Instantaneous Contact	4-1 (NC)		3-1 (NO)		Indicator	POWER		OUT		<table border="1"> <thead> <tr> <th>Item</th> <th>Terminal No.</th> <th>Operation</th> </tr> </thead> <tbody> <tr> <td>Power</td> <td>2-7</td> <td></td> </tr> <tr> <td rowspan="2">Delayed Contact</td> <td>5-8,4-1 (NC)</td> <td></td> </tr> <tr> <td>6-8,3-1 (NO)</td> <td></td> </tr> <tr> <td rowspan="2">Indicator</td> <td>POWER</td> <td></td> </tr> <tr> <td>OUT</td> <td></td> </tr> </tbody> </table>	Item	Terminal No.	Operation	Power	2-7		Delayed Contact	5-8,4-1 (NC)		6-8,3-1 (NO)		Indicator	POWER		OUT	
		Item	Terminal No.	Operation																																																					
		Power	2-7																																																						
		Delayed Contact	5-8 (NC)																																																						
			6-8 (NO)																																																						
Indicator	POWER																																																								
	OUT																																																								
Item	Terminal No.	Operation																																																							
Power	2-7																																																								
Delayed Contact	5-8 (NC)																																																								
	6-8 (NO)																																																								
Instantaneous Contact	4-1 (NC)																																																								
	3-1 (NO)																																																								
Indicator	POWER																																																								
	OUT																																																								
Item	Terminal No.	Operation																																																							
Power	2-7																																																								
Delayed Contact	5-8,4-1 (NC)																																																								
	6-8,3-1 (NO)																																																								
Indicator	POWER																																																								
	OUT																																																								
Cycle ON (ON start)	MODE D Functions in same manner as Mode C, with the exception that first transfer of contacts occurs as soon as power is applied. The ratio is 1:1. Time Off = Time On	<table border="1"> <thead> <tr> <th>Item</th> <th>Terminal No.</th> <th>Operation</th> </tr> </thead> <tbody> <tr> <td>Power</td> <td>2-7</td> <td></td> </tr> <tr> <td rowspan="2">Delayed Contact</td> <td>5-8 (NC)</td> <td></td> </tr> <tr> <td>6-8 (NO)</td> <td></td> </tr> <tr> <td rowspan="2">Indicator</td> <td>POWER</td> <td></td> </tr> <tr> <td>OUT</td> <td></td> </tr> </tbody> </table>	Item	Terminal No.	Operation	Power	2-7		Delayed Contact	5-8 (NC)		6-8 (NO)		Indicator	POWER		OUT		<table border="1"> <thead> <tr> <th>Item</th> <th>Terminal No.</th> <th>Operation</th> </tr> </thead> <tbody> <tr> <td>Power</td> <td>2-7</td> <td></td> </tr> <tr> <td rowspan="2">Delayed Contact</td> <td>5-8 (NC)</td> <td></td> </tr> <tr> <td>6-8 (NO)</td> <td></td> </tr> <tr> <td rowspan="2">Instantaneous Contact</td> <td>4-1 (NC)</td> <td></td> </tr> <tr> <td>3-1 (NO)</td> <td></td> </tr> <tr> <td rowspan="2">Indicator</td> <td>POWER</td> <td></td> </tr> <tr> <td>OUT</td> <td></td> </tr> </tbody> </table>	Item	Terminal No.	Operation	Power	2-7		Delayed Contact	5-8 (NC)		6-8 (NO)		Instantaneous Contact	4-1 (NC)		3-1 (NO)		Indicator	POWER		OUT		<table border="1"> <thead> <tr> <th>Item</th> <th>Terminal No.</th> <th>Operation</th> </tr> </thead> <tbody> <tr> <td>Power</td> <td>2-7</td> <td></td> </tr> <tr> <td rowspan="2">Delayed Contact</td> <td>5-8,4-1 (NC)</td> <td></td> </tr> <tr> <td>6-8,3-1 (NO)</td> <td></td> </tr> <tr> <td rowspan="2">Indicator</td> <td>POWER</td> <td></td> </tr> <tr> <td>OUT</td> <td></td> </tr> </tbody> </table>	Item	Terminal No.	Operation	Power	2-7		Delayed Contact	5-8,4-1 (NC)		6-8,3-1 (NO)		Indicator	POWER		OUT	
		Item	Terminal No.	Operation																																																					
		Power	2-7																																																						
		Delayed Contact	5-8 (NC)																																																						
			6-8 (NO)																																																						
Indicator	POWER																																																								
	OUT																																																								
Item	Terminal No.	Operation																																																							
Power	2-7																																																								
Delayed Contact	5-8 (NC)																																																								
	6-8 (NO)																																																								
Instantaneous Contact	4-1 (NC)																																																								
	3-1 (NO)																																																								
Indicator	POWER																																																								
	OUT																																																								
Item	Terminal No.	Operation																																																							
Power	2-7																																																								
Delayed Contact	5-8,4-1 (NC)																																																								
	6-8,3-1 (NO)																																																								
Indicator	POWER																																																								
	OUT																																																								

GT3 Series [Multi-Mode Type with Inputs (11 Pins)]

GT3A-4, -5, -6

Four Selectable Operation Modes with Start, Gate, and Reset Inputs for External Control

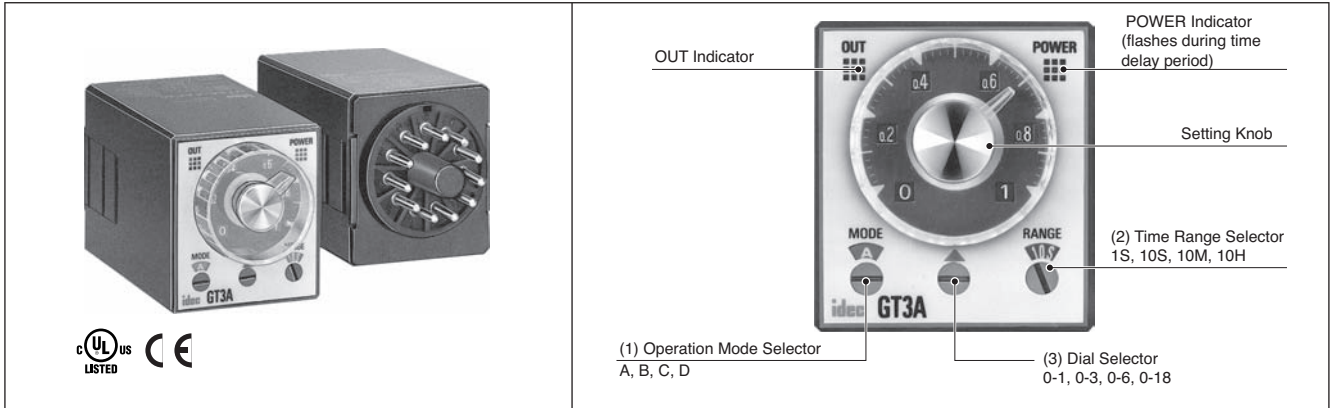

Type List

(1) Operation Mode	Rated Voltage Code	Time Ranges	Output	Contact	Input	Type No.
A: ON Delay B: Cycle OFF C: Signal ON Delay D: Signal OFF Delay	100 to 240V AC 24V AC/24V DC	0.1 sec to 180 hours See Time Ranges for details	240V AC, 5A 24V DC, 5A (resistive load)	Delayed DPDT	Start Reset Gate	GT3A-4AF20
A: Interval ON C: Signal ON/OFF Delay	100 to 240V AC 24V AC/24V DC					GT3A-4AD24
B: One-Shot Cycle, D: Signal OFF Delay	100 to 240V AC 24V AC/24V DC					GT3A-5AF20
A: One-Shot C: One-Shot	100 to 240V AC 24V AC/24V DC					GT3A-5AD24
B: One-Shot ON Delay D: Signal ON/OFF Delay	100 to 240V AC 24V AC/24V DC					GT3A-6AF20
						GT3A-6AD24

Time Ranges

(2) Range	(3) Dial			
	0 - 1	0 - 3	0 - 6	0 - 18
1S	0.1 sec to 1 sec	0.1 sec to 3 sec	0.1 sec to 6 sec	0.2 sec to 18 sec
10S	0.1 sec to 10 sec	0.3 sec to 30 sec	0.6 sec to 60 sec	1.8 sec to 180 sec
10M	6 sec to 10 min	18 sec to 30 min	36 sec to 60 min	108 sec to 180 min
10H	6 min to 10 hours	18 min to 30 hours	36 min to 60 hours	108 min to 180 hours

General Specifications

Operation System	Solid-state CMOS circuitry	
Operation Type	Multi-mode with inputs (11 pins)	
Time Range	0.1 sec to 180 hours	
Pollution Degree	2 (IEC60664-1)	
Overvoltage Category	III (IEC60664-1)	
Rated Voltage	AF20	100 to 240V AC (50/60Hz)
	AD24	24V AC (50/60Hz)/24V DC
Voltage Range	AF20	85 to 264V AC (50/60Hz)
	AD24	20.4 to 26.4V AC (50/60Hz)/21.6 to 26.4V DC
Reset Voltage	Rated voltage 10% minimum	
Operating Temperature	-10 to +50°C (no freezing)	
Storage/Transportation Temperature	-30 to +70°C (no freezing)	
Operating Humidity	35 to 85% RH (no condensation)	
Altitude	0 to 2000m (operation) 0 to 3000m (transportation)	
Reset Time	60 ms maximum	
Repeat Error	±0.2%, ±10 ms (Note)	
Voltage Error	±0.2%, ±10 ms (Note)	
Temperature Error	±0.2%, ±10 ms (Note)	
Setting Error	±10% maximum	
Insulation Resistance	100MΩ minimum (500V DC megger)	
Dielectric Strength	Between power and output terminals: 2000V AC, 1 minute	
	Between contacts of different poles: 2000V AC, 1 minute	
	Between contacts of the same pole: 1000V AC, 1 minute	
Vibration Resistance	10 to 55 Hz, amplitude 0.75 mm, 2 hours each in 3 directions	
Shock Resistance	Operating extremes: 98 m/s ² Damage limits: 490 m/s ² 3 shocks each in 6 directions	
Degree of Protection	IP40 (timer), IP20 (socket) (IEC60529)	
Power Consumption (Approx.)	AF20	2.2VA (100V AC/60Hz), 4.1VA (200V AC/60Hz)
	AD24	1.8VA (AC)/0.7W (DC)
Dimensions	40H 36W 72.2D mm	
Weight (approx.)	80g	

Note: The largest value becomes the error against a preset value depending on the time range.

Contact Ratings

Rated Load	240V AC/24V DC, 5A (resistive load)	
Maximum Switching Power	AC: 1200VA DC: 120W	
Maximum Switching Voltage	250V AC/150V DC	
Maximum Switching Current	5A	
Maximum Switching Frequency	1800 operations/hour	
Minimum Applicable Load	5V DC, 10 mA (reference value)	
External Protection Element	Fuse 250V, 5A	
Life	Electrical	100,000 operations minimum (rated load)
	Mechanical	20,000,000 operations minimum

Input Specifications

Start Input	The start input initiates delayed operation and controls output status.	No-voltage contact inputs and NPN open collector transistor inputs are applicable. 24V DC, 1 mA maximum Input response time: 50 ms maximum
Reset Input	When the reset input goes on (L level), the timer is reset to the original time (time at power-on).	
Gate Input	The time delay operation is suspended while the gate input is on (L level).	

GT3 Series [Multi-Mode Type with Inputs (11 Pins)]

Operation Chart





GT3A-4

Note: While the gate input is on during time delay operation, the POWER indicator flashing slows down.

Contact		Operation Chart Delayed DPDT																												
Internal Connection																														
		<p>Note: T = Set time Ta = Shorter than set time T = T' + T''</p>																												
Operation Mode Selection																														
On Delay	<p>MODE A</p> <p>Power is applied to timer at all times. Set time for desired delay. When start input is supplied time delay starts, contacts transfer after preset time has elapsed. Contacts remain in transferred position until timer is reset.</p>	<table border="1"> <thead> <tr> <th>Item</th> <th>Terminal No.</th> <th>Operation</th> </tr> </thead> <tbody> <tr> <td>Power</td> <td>2-10</td> <td>[Continuous High]</td> </tr> <tr> <td rowspan="3">Input</td> <td>Start</td> <td>6-2 ON or L</td> </tr> <tr> <td>Reset</td> <td>7-2 ON or L</td> </tr> <tr> <td>Gate</td> <td>5-2 ON or L</td> </tr> <tr> <td rowspan="3">Delayed Contact</td> <td>4-1 (NC)</td> <td>[High]</td> </tr> <tr> <td>8-11 (NC)</td> <td>[High]</td> </tr> <tr> <td>3-1 (NO)</td> <td>[Low]</td> </tr> <tr> <td rowspan="2">Indicator</td> <td>POWER</td> <td>[Flashing]</td> </tr> <tr> <td>OUT</td> <td>[Low]</td> </tr> <tr> <td>Set Time</td> <td></td> <td>T, Ta, T', T''</td> </tr> </tbody> </table>	Item	Terminal No.	Operation	Power	2-10	[Continuous High]	Input	Start	6-2 ON or L	Reset	7-2 ON or L	Gate	5-2 ON or L	Delayed Contact	4-1 (NC)	[High]	8-11 (NC)	[High]	3-1 (NO)	[Low]	Indicator	POWER	[Flashing]	OUT	[Low]	Set Time		T, Ta, T', T''
Item	Terminal No.	Operation																												
Power	2-10	[Continuous High]																												
Input	Start	6-2 ON or L																												
	Reset	7-2 ON or L																												
	Gate	5-2 ON or L																												
Delayed Contact	4-1 (NC)	[High]																												
	8-11 (NC)	[High]																												
	3-1 (NO)	[Low]																												
Indicator	POWER	[Flashing]																												
	OUT	[Low]																												
Set Time		T, Ta, T', T''																												
Cycle	<p>MODE B</p> <p>Power is applied to timer at all times. Set timer for desired delay, initiate start input. Contacts transfer after preset time has elapsed and remain in transferred position until preset time elapses a second time. The timer will now continue to cycle in above manner until reset applied.</p>	<table border="1"> <thead> <tr> <th>Item</th> <th>Terminal No.</th> <th>Operation</th> </tr> </thead> <tbody> <tr> <td>Power</td> <td>2-10</td> <td>[Continuous High]</td> </tr> <tr> <td rowspan="3">Input</td> <td>Start</td> <td>6-2 ON or L</td> </tr> <tr> <td>Reset</td> <td>7-2 ON or L</td> </tr> <tr> <td>Gate</td> <td>5-2 ON or L</td> </tr> <tr> <td rowspan="3">Delayed Contact</td> <td>4-1 (NC)</td> <td>[High]</td> </tr> <tr> <td>8-11 (NC)</td> <td>[High]</td> </tr> <tr> <td>3-1 (NO)</td> <td>[Low]</td> </tr> <tr> <td rowspan="2">Indicator</td> <td>POWER</td> <td>[Flashing]</td> </tr> <tr> <td>OUT</td> <td>[Low]</td> </tr> <tr> <td>Set Time</td> <td></td> <td>T, Ta, T', T''</td> </tr> </tbody> </table>	Item	Terminal No.	Operation	Power	2-10	[Continuous High]	Input	Start	6-2 ON or L	Reset	7-2 ON or L	Gate	5-2 ON or L	Delayed Contact	4-1 (NC)	[High]	8-11 (NC)	[High]	3-1 (NO)	[Low]	Indicator	POWER	[Flashing]	OUT	[Low]	Set Time		T, Ta, T', T''
Item	Terminal No.	Operation																												
Power	2-10	[Continuous High]																												
Input	Start	6-2 ON or L																												
	Reset	7-2 ON or L																												
	Gate	5-2 ON or L																												
Delayed Contact	4-1 (NC)	[High]																												
	8-11 (NC)	[High]																												
	3-1 (NO)	[Low]																												
Indicator	POWER	[Flashing]																												
	OUT	[Low]																												
Set Time		T, Ta, T', T''																												
Signal ON/OFF Delay	<p>MODE C</p> <p>For this mode a maintained pushbutton is required for start input. Power is applied to timer at all times. Set timer for desired delay, initiate start input. Contacts will transfer immediately. After preset time (with start input still present) contacts will transfer back to original position. Remove start signal, at this time contacts will again transfer. Contacts will transfer to original position after preset time. Timer is reset by initiation of reset input.</p>	<table border="1"> <thead> <tr> <th>Item</th> <th>Terminal No.</th> <th>Operation</th> </tr> </thead> <tbody> <tr> <td>Power</td> <td>2-10</td> <td>[Continuous High]</td> </tr> <tr> <td rowspan="3">Input</td> <td>Start</td> <td>6-2 ON or L</td> </tr> <tr> <td>Reset</td> <td>7-2 ON or L</td> </tr> <tr> <td>Gate</td> <td>5-2 ON or L</td> </tr> <tr> <td rowspan="3">Delayed Contact</td> <td>4-1 (NC)</td> <td>[High]</td> </tr> <tr> <td>8-11 (NC)</td> <td>[High]</td> </tr> <tr> <td>3-1 (NO)</td> <td>[Low]</td> </tr> <tr> <td rowspan="2">Indicator</td> <td>POWER</td> <td>[Flashing]</td> </tr> <tr> <td>OUT</td> <td>[Low]</td> </tr> <tr> <td>Set Time</td> <td></td> <td>T, Ta, T', T''</td> </tr> </tbody> </table>	Item	Terminal No.	Operation	Power	2-10	[Continuous High]	Input	Start	6-2 ON or L	Reset	7-2 ON or L	Gate	5-2 ON or L	Delayed Contact	4-1 (NC)	[High]	8-11 (NC)	[High]	3-1 (NO)	[Low]	Indicator	POWER	[Flashing]	OUT	[Low]	Set Time		T, Ta, T', T''
Item	Terminal No.	Operation																												
Power	2-10	[Continuous High]																												
Input	Start	6-2 ON or L																												
	Reset	7-2 ON or L																												
	Gate	5-2 ON or L																												
Delayed Contact	4-1 (NC)	[High]																												
	8-11 (NC)	[High]																												
	3-1 (NO)	[Low]																												
Indicator	POWER	[Flashing]																												
	OUT	[Low]																												
Set Time		T, Ta, T', T''																												
Signal OFF Delay	<p>MODE D</p> <p>Power is applied to timer at all times. Set timer for desired delay, initiate start input. Contacts immediately transfer. When start input is removed time delay starts. After preset time contacts transfer back to original position. Timer is reset by initiation of reset input.</p>	<table border="1"> <thead> <tr> <th>Item</th> <th>Terminal No.</th> <th>Operation</th> </tr> </thead> <tbody> <tr> <td>Power</td> <td>2-10</td> <td>[Continuous High]</td> </tr> <tr> <td rowspan="3">Input</td> <td>Start</td> <td>6-2 ON or L</td> </tr> <tr> <td>Reset</td> <td>7-2 ON or L</td> </tr> <tr> <td>Gate</td> <td>5-2 ON or L</td> </tr> <tr> <td rowspan="3">Delayed Contact</td> <td>4-1 (NC)</td> <td>[High]</td> </tr> <tr> <td>8-11 (NC)</td> <td>[High]</td> </tr> <tr> <td>3-1 (NO)</td> <td>[Low]</td> </tr> <tr> <td rowspan="2">Indicator</td> <td>POWER</td> <td>[Flashing]</td> </tr> <tr> <td>OUT</td> <td>[Low]</td> </tr> <tr> <td>Set Time</td> <td></td> <td>T, Ta, T', T''</td> </tr> </tbody> </table>	Item	Terminal No.	Operation	Power	2-10	[Continuous High]	Input	Start	6-2 ON or L	Reset	7-2 ON or L	Gate	5-2 ON or L	Delayed Contact	4-1 (NC)	[High]	8-11 (NC)	[High]	3-1 (NO)	[Low]	Indicator	POWER	[Flashing]	OUT	[Low]	Set Time		T, Ta, T', T''
Item	Terminal No.	Operation																												
Power	2-10	[Continuous High]																												
Input	Start	6-2 ON or L																												
	Reset	7-2 ON or L																												
	Gate	5-2 ON or L																												
Delayed Contact	4-1 (NC)	[High]																												
	8-11 (NC)	[High]																												
	3-1 (NO)	[Low]																												
Indicator	POWER	[Flashing]																												
	OUT	[Low]																												
Set Time		T, Ta, T', T''																												

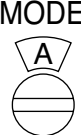
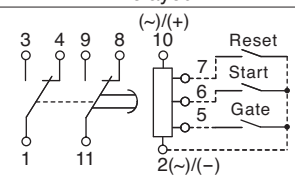
GT3 Series [Multi-Mode Type with Inputs (11 Pins)]





GT3A-5

Contact		Operation Chart																																						
Internal Connection		Delayed DPDT																																						
<p>Operation Mode Selection</p> <p>Interval ON</p> <div style="text-align: center;">  <p>MODE A</p> </div> <p>Power is applied to timer at all times. Set timer for desired delay, initiate start input. Contacts immediately transfer. After preset delay contacts return to original position. Timer is reset by initiation of reset input.</p>	<div style="text-align: center;">  </div> <p>Note: T = Set time Ta = Shorter than set time T = T' + T''</p>																																							
<p>One-Shot Cycle</p> <div style="text-align: center;">  <p>MODE B</p> </div> <p>Power is applied to timer at all times. Set timer for desired delay, initiate start input. After preset time has elapsed contacts will transfer. Contacts will transfer to their original position after preset time elapses a second time. Timer is reset by initiation of reset input.</p>	<table border="1" style="width: 100%; border-collapse: collapse;"> <thead> <tr> <th>Item</th> <th>Terminal No.</th> <th colspan="2">Operation</th> </tr> </thead> <tbody> <tr> <td>Power</td> <td>2-10</td> <td colspan="2" style="text-align: center;">[Power Pulse]</td> </tr> <tr> <td rowspan="3">Input</td> <td>Start 6-2 ON or L</td> <td colspan="2" style="text-align: center;">[Start Pulse]</td> </tr> <tr> <td>Reset 7-2 ON or L</td> <td colspan="2" style="text-align: center;">[Reset Pulse]</td> </tr> <tr> <td>Gate 5-2 ON or L</td> <td colspan="2" style="text-align: center;">[Gate Pulse]</td> </tr> <tr> <td rowspan="3">Delayed Contact</td> <td>4-1 (NC) 8-11 (NC)</td> <td colspan="2" style="text-align: center;">[NC Contact State]</td> </tr> <tr> <td>3-1 (NO) 9-11 (NO)</td> <td colspan="2" style="text-align: center;">[NO Contact State]</td> </tr> <tr> <td>Indicator</td> <td>POWER</td> <td colspan="2" style="text-align: center;">[Indicator Pulse]</td> </tr> <tr> <td></td> <td>OUT</td> <td colspan="2" style="text-align: center;">[Indicator Pulse]</td> </tr> <tr> <td>Set Time</td> <td></td> <td colspan="2" style="text-align: center;">[Timing Diagram with T, Ta, T', T'' labels]</td> </tr> </tbody> </table>	Item	Terminal No.	Operation		Power	2-10	[Power Pulse]		Input	Start 6-2 ON or L	[Start Pulse]		Reset 7-2 ON or L	[Reset Pulse]		Gate 5-2 ON or L	[Gate Pulse]		Delayed Contact	4-1 (NC) 8-11 (NC)	[NC Contact State]		3-1 (NO) 9-11 (NO)	[NO Contact State]		Indicator	POWER	[Indicator Pulse]			OUT	[Indicator Pulse]		Set Time		[Timing Diagram with T, Ta, T', T'' labels]			
Item	Terminal No.	Operation																																						
Power	2-10	[Power Pulse]																																						
Input	Start 6-2 ON or L	[Start Pulse]																																						
	Reset 7-2 ON or L	[Reset Pulse]																																						
	Gate 5-2 ON or L	[Gate Pulse]																																						
Delayed Contact	4-1 (NC) 8-11 (NC)	[NC Contact State]																																						
	3-1 (NO) 9-11 (NO)	[NO Contact State]																																						
	Indicator	POWER	[Indicator Pulse]																																					
	OUT	[Indicator Pulse]																																						
Set Time		[Timing Diagram with T, Ta, T', T'' labels]																																						
<p>Signal ON/OFF Delay</p> <div style="text-align: center;">  <p>MODE C</p> </div> <p>For this mode a maintained pushbutton is required for start input. Power is applied to timer at all times. Set timer for desired delay, initiate start input. Contacts will transfer immediately. After preset time (with start input still present) contacts will transfer back to original position. Remove start signal, at this time contacts will again transfer. Contacts will transfer to original position after preset time. Timer is reset by initiation of reset input.</p>	<table border="1" style="width: 100%; border-collapse: collapse;"> <thead> <tr> <th>Item</th> <th>Terminal No.</th> <th colspan="2">Operation</th> </tr> </thead> <tbody> <tr> <td>Power</td> <td>2-10</td> <td colspan="2" style="text-align: center;">[Power Pulse]</td> </tr> <tr> <td rowspan="3">Input</td> <td>Start 6-2 ON or L</td> <td colspan="2" style="text-align: center;">[Start Pulse]</td> </tr> <tr> <td>Reset 7-2 ON or L</td> <td colspan="2" style="text-align: center;">[Reset Pulse]</td> </tr> <tr> <td>Gate 5-2 ON or L</td> <td colspan="2" style="text-align: center;">[Gate Pulse]</td> </tr> <tr> <td rowspan="3">Delayed Contact</td> <td>4-1 (NC) 8-11 (NC)</td> <td colspan="2" style="text-align: center;">[NC Contact State]</td> </tr> <tr> <td>3-1 (NO) 9-11 (NO)</td> <td colspan="2" style="text-align: center;">[NO Contact State]</td> </tr> <tr> <td>Indicator</td> <td>POWER</td> <td colspan="2" style="text-align: center;">[Indicator Pulse]</td> </tr> <tr> <td></td> <td>OUT</td> <td colspan="2" style="text-align: center;">[Indicator Pulse]</td> </tr> <tr> <td>Set Time</td> <td></td> <td colspan="2" style="text-align: center;">[Timing Diagram with T, Ta, T', T'' labels]</td> </tr> </tbody> </table>	Item	Terminal No.	Operation		Power	2-10	[Power Pulse]		Input	Start 6-2 ON or L	[Start Pulse]		Reset 7-2 ON or L	[Reset Pulse]		Gate 5-2 ON or L	[Gate Pulse]		Delayed Contact	4-1 (NC) 8-11 (NC)	[NC Contact State]		3-1 (NO) 9-11 (NO)	[NO Contact State]		Indicator	POWER	[Indicator Pulse]			OUT	[Indicator Pulse]		Set Time		[Timing Diagram with T, Ta, T', T'' labels]			
Item	Terminal No.	Operation																																						
Power	2-10	[Power Pulse]																																						
Input	Start 6-2 ON or L	[Start Pulse]																																						
	Reset 7-2 ON or L	[Reset Pulse]																																						
	Gate 5-2 ON or L	[Gate Pulse]																																						
Delayed Contact	4-1 (NC) 8-11 (NC)	[NC Contact State]																																						
	3-1 (NO) 9-11 (NO)	[NO Contact State]																																						
	Indicator	POWER	[Indicator Pulse]																																					
	OUT	[Indicator Pulse]																																						
Set Time		[Timing Diagram with T, Ta, T', T'' labels]																																						
<p>Signal OFF Delay</p> <div style="text-align: center;">  <p>MODE D</p> </div> <p>Power is applied to timer at all times. Set timer for desired delay, initiate start input. Contacts immediately transfer. When start input is removed time delay starts. After preset time contacts transfer back to original position. Timer is reset by initiation of reset input.</p>	<table border="1" style="width: 100%; border-collapse: collapse;"> <thead> <tr> <th>Item</th> <th>Terminal No.</th> <th colspan="2">Operation</th> </tr> </thead> <tbody> <tr> <td>Power</td> <td>2-10</td> <td colspan="2" style="text-align: center;">[Power Pulse]</td> </tr> <tr> <td rowspan="3">Input</td> <td>Start 6-2 ON or L</td> <td colspan="2" style="text-align: center;">[Start Pulse]</td> </tr> <tr> <td>Reset 7-2 ON or L</td> <td colspan="2" style="text-align: center;">[Reset Pulse]</td> </tr> <tr> <td>Gate 5-2 ON or L</td> <td colspan="2" style="text-align: center;">[Gate Pulse]</td> </tr> <tr> <td rowspan="3">Delayed Contact</td> <td>4-1 (NC) 8-11 (NC)</td> <td colspan="2" style="text-align: center;">[NC Contact State]</td> </tr> <tr> <td>3-1 (NO) 9-11 (NO)</td> <td colspan="2" style="text-align: center;">[NO Contact State]</td> </tr> <tr> <td>Indicator</td> <td>POWER</td> <td colspan="2" style="text-align: center;">[Indicator Pulse]</td> </tr> <tr> <td></td> <td>OUT</td> <td colspan="2" style="text-align: center;">[Indicator Pulse]</td> </tr> <tr> <td>Set Time</td> <td></td> <td colspan="2" style="text-align: center;">[Timing Diagram with T, Ta, T', T'' labels]</td> </tr> </tbody> </table>	Item	Terminal No.	Operation		Power	2-10	[Power Pulse]		Input	Start 6-2 ON or L	[Start Pulse]		Reset 7-2 ON or L	[Reset Pulse]		Gate 5-2 ON or L	[Gate Pulse]		Delayed Contact	4-1 (NC) 8-11 (NC)	[NC Contact State]		3-1 (NO) 9-11 (NO)	[NO Contact State]		Indicator	POWER	[Indicator Pulse]			OUT	[Indicator Pulse]		Set Time		[Timing Diagram with T, Ta, T', T'' labels]			
Item	Terminal No.	Operation																																						
Power	2-10	[Power Pulse]																																						
Input	Start 6-2 ON or L	[Start Pulse]																																						
	Reset 7-2 ON or L	[Reset Pulse]																																						
	Gate 5-2 ON or L	[Gate Pulse]																																						
Delayed Contact	4-1 (NC) 8-11 (NC)	[NC Contact State]																																						
	3-1 (NO) 9-11 (NO)	[NO Contact State]																																						
	Indicator	POWER	[Indicator Pulse]																																					
	OUT	[Indicator Pulse]																																						
Set Time		[Timing Diagram with T, Ta, T', T'' labels]																																						

- Flush Silhouette
- Control Units
- Display Lights
- Display Units
- Safety Products
- Terminal Blocks
- Comm. Terminals
- AS-Interface
- Relays & Timers
- Sockets
- Circuit Protectors
- Power Supplies
- PLCs & SmartRelay
- Operator Interfaces
- Sensors
- Control Stations
- Explosion Protection
- References

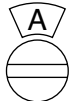
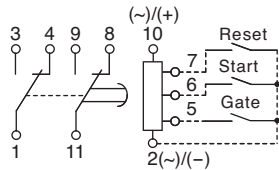
GT3 Series [Multi-Mode Type with Inputs (11 Pins)]

GT3A-6

Contact		Operation Chart																									
Internal Connection		Delayed DPDT																									
<p>Operation Mode Selection</p> <p>One Shot</p> <p>MODE A</p>  <p>Power is applied to timer at all times. Set timer for desired delay, initiate start input. Contacts immediately transfer. After preset time has elapsed contacts transfer back to original position. Reset occurs with initiation of reset input.</p>		 <p>Note: T = Set time Ta = Shorter than set time T = T' + T''</p>																									
<p>One Shot ON Delay</p> <p>MODE B</p>  <p>Set timer for desired delay. When power is applied preset time begins and contacts transfer after preset time has elapsed (no start input needed at this time). Start input is now supplied, this causes the contacts to transfer back to original position. Contacts will remain in this position for preset time, after which they will transfer again. Contacts will now remain in this position until: reset, start input is applied again or power is removed.</p>		<table border="1"> <thead> <tr> <th>Item</th> <th>Terminal No.</th> <th>Operation</th> </tr> </thead> <tbody> <tr> <td>Power</td> <td>2-10</td> <td>[Timing diagram showing power pulse]</td> </tr> <tr> <td rowspan="3">Input</td> <td>Start: 6-2 ON or L</td> <td>[Timing diagram showing start pulses]</td> </tr> <tr> <td>Reset: 7-2 ON or L</td> <td>[Timing diagram showing reset pulses]</td> </tr> <tr> <td>Gate: 5-2 ON or L</td> <td>[Timing diagram showing gate pulses]</td> </tr> <tr> <td rowspan="3">Delayed Contact</td> <td>4-1 (NC) 8-11 (NC)</td> <td>[Timing diagram showing NC contact states]</td> </tr> <tr> <td>3-1 (NO) 9-11 (NO)</td> <td>[Timing diagram showing NO contact states]</td> </tr> <tr> <td>Indicator</td> <td>POWER OUT</td> <td>[Timing diagram showing indicator pulses]</td> </tr> <tr> <td>Set Time</td> <td></td> <td>[Timing diagram showing T, Ta, T', T'' intervals]</td> </tr> </tbody> </table>		Item	Terminal No.	Operation	Power	2-10	[Timing diagram showing power pulse]	Input	Start: 6-2 ON or L	[Timing diagram showing start pulses]	Reset: 7-2 ON or L	[Timing diagram showing reset pulses]	Gate: 5-2 ON or L	[Timing diagram showing gate pulses]	Delayed Contact	4-1 (NC) 8-11 (NC)	[Timing diagram showing NC contact states]	3-1 (NO) 9-11 (NO)	[Timing diagram showing NO contact states]	Indicator	POWER OUT	[Timing diagram showing indicator pulses]	Set Time		[Timing diagram showing T, Ta, T', T'' intervals]
Item	Terminal No.	Operation																									
Power	2-10	[Timing diagram showing power pulse]																									
Input	Start: 6-2 ON or L	[Timing diagram showing start pulses]																									
	Reset: 7-2 ON or L	[Timing diagram showing reset pulses]																									
	Gate: 5-2 ON or L	[Timing diagram showing gate pulses]																									
Delayed Contact	4-1 (NC) 8-11 (NC)	[Timing diagram showing NC contact states]																									
	3-1 (NO) 9-11 (NO)	[Timing diagram showing NO contact states]																									
	Indicator	POWER OUT	[Timing diagram showing indicator pulses]																								
Set Time		[Timing diagram showing T, Ta, T', T'' intervals]																									
<p>One Shot</p> <p>MODE C</p>  <p>Power is applied to timer at all times. Set timer for desired delay, initiate start input. Contacts immediately transfer. After preset time has elapsed contacts transfer back to original position. Reset occurs with initiation of reset input.</p>		<table border="1"> <thead> <tr> <th>Item</th> <th>Terminal No.</th> <th>Operation</th> </tr> </thead> <tbody> <tr> <td>Power</td> <td>2-10</td> <td>[Timing diagram showing power pulse]</td> </tr> <tr> <td rowspan="3">Input</td> <td>Start: 6-2 ON or L</td> <td>[Timing diagram showing start pulses]</td> </tr> <tr> <td>Reset: 7-2 ON or L</td> <td>[Timing diagram showing reset pulses]</td> </tr> <tr> <td>Gate: 5-2 ON or L</td> <td>[Timing diagram showing gate pulses]</td> </tr> <tr> <td rowspan="3">Delayed Contact</td> <td>4-1 (NC) 8-11 (NC)</td> <td>[Timing diagram showing NC contact states]</td> </tr> <tr> <td>3-1 (NO) 9-11 (NO)</td> <td>[Timing diagram showing NO contact states]</td> </tr> <tr> <td>Indicator</td> <td>POWER OUT</td> <td>[Timing diagram showing indicator pulses]</td> </tr> <tr> <td>Set Time</td> <td></td> <td>[Timing diagram showing T, Ta, T', T'' intervals]</td> </tr> </tbody> </table>		Item	Terminal No.	Operation	Power	2-10	[Timing diagram showing power pulse]	Input	Start: 6-2 ON or L	[Timing diagram showing start pulses]	Reset: 7-2 ON or L	[Timing diagram showing reset pulses]	Gate: 5-2 ON or L	[Timing diagram showing gate pulses]	Delayed Contact	4-1 (NC) 8-11 (NC)	[Timing diagram showing NC contact states]	3-1 (NO) 9-11 (NO)	[Timing diagram showing NO contact states]	Indicator	POWER OUT	[Timing diagram showing indicator pulses]	Set Time		[Timing diagram showing T, Ta, T', T'' intervals]
Item	Terminal No.	Operation																									
Power	2-10	[Timing diagram showing power pulse]																									
Input	Start: 6-2 ON or L	[Timing diagram showing start pulses]																									
	Reset: 7-2 ON or L	[Timing diagram showing reset pulses]																									
	Gate: 5-2 ON or L	[Timing diagram showing gate pulses]																									
Delayed Contact	4-1 (NC) 8-11 (NC)	[Timing diagram showing NC contact states]																									
	3-1 (NO) 9-11 (NO)	[Timing diagram showing NO contact states]																									
	Indicator	POWER OUT	[Timing diagram showing indicator pulses]																								
Set Time		[Timing diagram showing T, Ta, T', T'' intervals]																									
<p>Signal ON/OFF Delay</p> <p>MODE D</p>  <p>For this mode a maintained pushbutton is required for start input. Power is applied to timer at all times. Set timer for desired delay, initiate start input. Contacts will transfer immediately. After preset time (with start input still present) contacts will transfer back to original position. Remove start signal, at this time contacts will again transfer. Contacts will transfer to original position after preset time. Timer is reset by initiation of reset input.</p>		<table border="1"> <thead> <tr> <th>Item</th> <th>Terminal No.</th> <th>Operation</th> </tr> </thead> <tbody> <tr> <td>Power</td> <td>2-10</td> <td>[Timing diagram showing power pulse]</td> </tr> <tr> <td rowspan="3">Input</td> <td>Start: 6-2 ON or L</td> <td>[Timing diagram showing start pulses]</td> </tr> <tr> <td>Reset: 7-2 ON or L</td> <td>[Timing diagram showing reset pulses]</td> </tr> <tr> <td>Gate: 5-2 ON or L</td> <td>[Timing diagram showing gate pulses]</td> </tr> <tr> <td rowspan="3">Delayed Contact</td> <td>4-1 (NC) 8-11 (NC)</td> <td>[Timing diagram showing NC contact states]</td> </tr> <tr> <td>3-1 (NO) 9-11 (NO)</td> <td>[Timing diagram showing NO contact states]</td> </tr> <tr> <td>Indicator</td> <td>POWER OUT</td> <td>[Timing diagram showing indicator pulses]</td> </tr> <tr> <td>Set Time</td> <td></td> <td>[Timing diagram showing T, Ta, T', T'' intervals]</td> </tr> </tbody> </table>		Item	Terminal No.	Operation	Power	2-10	[Timing diagram showing power pulse]	Input	Start: 6-2 ON or L	[Timing diagram showing start pulses]	Reset: 7-2 ON or L	[Timing diagram showing reset pulses]	Gate: 5-2 ON or L	[Timing diagram showing gate pulses]	Delayed Contact	4-1 (NC) 8-11 (NC)	[Timing diagram showing NC contact states]	3-1 (NO) 9-11 (NO)	[Timing diagram showing NO contact states]	Indicator	POWER OUT	[Timing diagram showing indicator pulses]	Set Time		[Timing diagram showing T, Ta, T', T'' intervals]
Item	Terminal No.	Operation																									
Power	2-10	[Timing diagram showing power pulse]																									
Input	Start: 6-2 ON or L	[Timing diagram showing start pulses]																									
	Reset: 7-2 ON or L	[Timing diagram showing reset pulses]																									
	Gate: 5-2 ON or L	[Timing diagram showing gate pulses]																									
Delayed Contact	4-1 (NC) 8-11 (NC)	[Timing diagram showing NC contact states]																									
	3-1 (NO) 9-11 (NO)	[Timing diagram showing NO contact states]																									
	Indicator	POWER OUT	[Timing diagram showing indicator pulses]																								
Set Time		[Timing diagram showing T, Ta, T', T'' intervals]																									

GT3F-1/GT3F-2

Specifically designed type for Power OFF Delay. Reset Inputs are available.

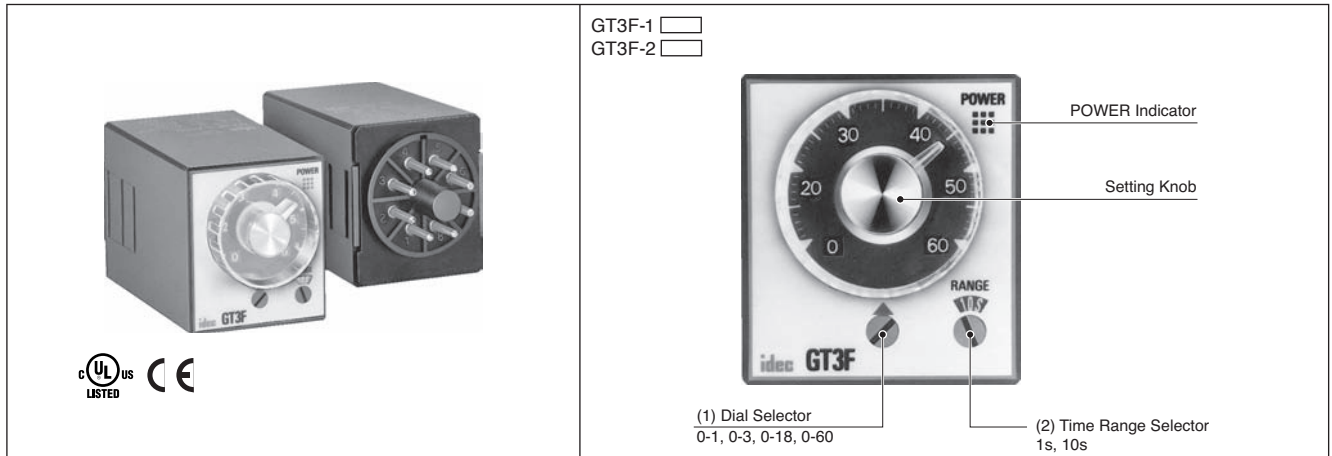

Type List

(1) Operation Mode	Rated Voltage Code	Time Ranges	Output	Contact	Input	Type No.
Power OFF Delay	100 to 240V AC	0.1 sec to 600 sec	250V AC /30V DC, 5A	Delayed SPDT	Reset	GT3F-1AF20
	24V AC/24V DC					GT3F-1AD24
	100 to 240V AC		250V AC /30V DC, 3A	Delayed DPDT	Without	GT3F-2AF20
	24V AC/24V DC					GT3F-2AD24

Time Ranges

GT3F-1/GT3F-2

(2) Range \ (3) Dial	0 - 1	0 - 3	0 - 18	0 - 60
1S	0.1 sec to 1 sec	0.1 sec to 3 sec	0.2 sec to 18 sec	0.6 sec to 60 sec
10S	0.1 sec to 10 sec	0.3 sec to 30 sec	1.8 sec to 180 sec	6 sec to 600 sec

Timeout Repeat Cycle	3 sec minimum
Reset Input Repeat Cycle	3 sec minimum

Contact Ratings

Type	GT3F-1	GT3F-2
Rated Load	250V AC/30V DC, 5A (resistive load)	250V AC/30V DC, 3A (resistive load)
Minimum Switching Power	AC: 1250VA DC: 150W	AC: 750VA DC: 90W
Minimum Switching Voltage	250V AC/125V DC	
Minimum Switching Current	5A	3A
Maximum Switching Frequency	1800 operations/hour	
Minimum Applicable Load	5V DC, 10 mA	5V DC, 100 mA
External Protection Element	Fuse 250V, 5A	Fuse 250V, 3A
Life	Electrical	100,000 operations minimum (rated load)
	Mechanical	10,000,000 operations minimum

Input Specifications

Reset Input	The contact is reset by turning the reset input on (L level). No-voltage contact input and NPN open collector transistor input are applicable. 6V DC, 0.6 mA maximum Input Response Time (AC Type): ON: 50 ms maximum OFF: 1 sec maximum
-------------	------------------------------------------------------------------------------------------------------------------------------------------------------------------------------------------------------------------------------------------------------

General Specifications

Operation System	Solid-state CMOS circuitry	
Operation Type	Power OFF delay	
Time Range	0.1 sec to 600 hours	
Pollution Degree	2 (IEC60664-1)	
Overvoltage Category	III (IEC60664-1)	
Rated Voltage	AF20	100 to 240V AC (50/60Hz)
	AD24	24V AC (50/60Hz)/24V DC
Voltage Range	AF20	85 to 264V AC (50/60Hz)
	AD24	20.4 to 26.4V AC (50/60Hz)/21.6 to 26.4V DC
Time Delay Operation Start Voltage	Rated Voltage 10% minimum	
Minimum Power Application Time (Note 1)	0.4 sec (time range: 180 sec or less) 1 sec (time range: 600 sec)	
Operating Temperature	-10 to +50°C (no freezing)	
Storage/Transportation Temperature	-30 to +70°C (no freezing)	
Operating Humidity	35 to 85% RH (no condensation)	
Altitude	0 to 2000m (operation) 0 to 3000m (transportation)	
Repeat Error	±0.2%, ±10 ms (Note 2)	
Voltage Error	±0.2%, ±10 ms (Note 2)	
Temperature Error	±0.2%, ±10 ms (Note 2)	
Setting Error	±10% maximum	
Insulation Resistance	100 MΩ min. (500V DC megger)	
Dielectric Strength	Between power and output terminals: 2000V AC, 1 minute	
	Between contacts of different poles: 2000V AC, 1 minute	
	Between contacts of the same pole: 1000V AC, 1 minute	
Vibration Resistance	10 to 55Hz, amplitude 0.75 mm, 2 hours each in 3 directions	
Shock Resistance	Operating extremes: 98 m/s ² , Damage limits: 490 m/s ² , 3 shocks each in 6 directions	
Degree of Protection	IP40 (timer), IP20 (socket) (IEC60529)	
Power Consumption (approx.)	AF20	1.1 VA (100V AC/60Hz), 2.3 VA (200V AC/60Hz)
	AD24	0.7 VA (AC)/0.2W (DC)
Dimensions	40H 36W 72.2D mm	
Weight (approx.)	GT3F-1	77g
	GT3F-2	79g

Note 1: An inrush current flows during minimum power application time.
AF20: Approx. 0.4A, AD24: Approx. 1.2A

Note 2: The largest value becomes the error against a preset value depending on the time range.

GT3 Series [Power OFF Delay Type]

Operation Chart

Contact	Internal Connection	Operation Chart																				
GT3F-1 Delayed SPDT Output with Reset Input		<table border="1"> <thead> <tr> <th>Item</th> <th>Terminal No.</th> <th>Operation</th> </tr> </thead> <tbody> <tr> <td>Power</td> <td>2-7</td> <td></td> </tr> <tr> <td>Reset Input</td> <td>4-1 ON or L</td> <td></td> </tr> <tr> <td rowspan="2">Delayed Contact</td> <td>5-8 (NC)</td> <td></td> </tr> <tr> <td>6-8 (NO)</td> <td></td> </tr> <tr> <td>Indicator</td> <td>POWER</td> <td></td> </tr> <tr> <td>Set Time</td> <td></td> <td></td> </tr> </tbody> </table> <p> T = Set time Ta = Shorter than set time Ts = 1 sec Tr = Minimum power application time 0.4 sec (time range: 180 sec or less) 1 sec (time range: 600 sec or less) When power turns on, the NO output contact goes on. When a preset time has elapsed after the power has been turned off, the NO output contact goes off. The contact is reset by turning the reset input on. </p>	Item	Terminal No.	Operation	Power	2-7		Reset Input	4-1 ON or L		Delayed Contact	5-8 (NC)		6-8 (NO)		Indicator	POWER		Set Time		
Item	Terminal No.	Operation																				
Power	2-7																					
Reset Input	4-1 ON or L																					
Delayed Contact	5-8 (NC)																					
	6-8 (NO)																					
Indicator	POWER																					
Set Time																						
GT3F-2 Delayed DPDT Output		<table border="1"> <thead> <tr> <th>Item</th> <th>Terminal No.</th> <th>Operation</th> </tr> </thead> <tbody> <tr> <td>Power</td> <td>2-7</td> <td></td> </tr> <tr> <td rowspan="2">Delayed Contact</td> <td>5-8, 4-1 (NC)</td> <td></td> </tr> <tr> <td>6-8, 3-1 (NO)</td> <td></td> </tr> <tr> <td>Indicator</td> <td>POWER</td> <td></td> </tr> <tr> <td>Set Time</td> <td></td> <td></td> </tr> </tbody> </table> <p> T = Set time Tr = Minimum power application time 0.4 sec (time range: 180 sec or less) 1 sec (time range: 600 sec or less) When power turns on, the NO output contact goes on. When a preset time has elapsed after the power has been turned off, the NO output contact goes off. </p>	Item	Terminal No.	Operation	Power	2-7		Delayed Contact	5-8, 4-1 (NC)		6-8, 3-1 (NO)		Indicator	POWER		Set Time					
Item	Terminal No.	Operation																				
Power	2-7																					
Delayed Contact	5-8, 4-1 (NC)																					
	6-8, 3-1 (NO)																					
Indicator	POWER																					
Set Time																						

GT3S-1/GT3S-2

Star-Delta Output Mode

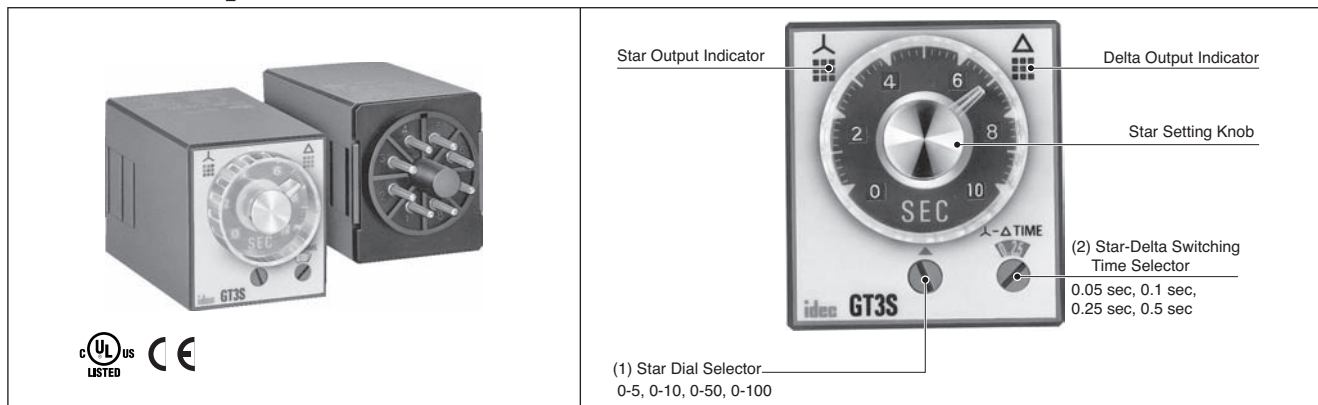

Type List

(1) Operation Mode	Rated Voltage	Time Range	Output	Contact	Type No.
Star-Delta	100 to 240V AC	Star: 0.05 to 100 sec Star-Delta switching time 0.05 sec 0.10 sec 0.25 sec 0.50 sec	250V AC/ 30V DC, 5A (resistive load)	Star: Delayed SPST-NO Delta: Delayed SPST-NO	GT3S-1AF20
				Star: Delayed SPST-NO Delta: Delayed SPST-NO Instantaneous SPST-NO	GT3S-2AF20

Time Ranges

① Star Dial Selector		② Star-Delta Switching Time Selector	
Dial	Time Range	Indication	Time
0 - 5	0.05 sec - 5 sec	0.05	0.05 sec
0 - 10	0.1 sec - 10 sec	0.1	0.1 sec
0 - 50	0.5 sec - 50 sec	0.25	0.25 sec
0 - 100	1 sec - 100 sec	0.5	0.5 sec

Contact Ratings

Rated Load	250V AC/30V DC, 5A (resistive load)	
Maximum Switching Power	AC: 1250VA DC: 150W	
Maximum Switching Voltage	265V AC/125V DC	
Maximum Switching Current	5A	
Maximum Switching Frequency	1800 operations/hour	
Minimum Applicable Load	5V DC, 100mA (reference value)	
External Protection Element	Fuse 250V, 5A	
Life	Electrical	100,000 operations minimum (rated load)
	Mechanical	20,000,000 operations minimum

General Specifications

Operation System	Solid-state CMOS circuitry	
Operation Type	Star-delta	
Time Range	Star side: 0.05 sec to 100 sec Star delta switching time: 0.05, 0.1, 0.25, 0.5 sec	
Pollution Degree	2 (IEC60664-1)	
Overvoltage Category	III (IEC60664-1)	
Rated Voltage	100 to 240V AC (50/60Hz)	
Voltage Range	85 to 264V AC (50/60Hz)	
Reset Voltage	Rated Voltage 10% minimum	
Operating Temperature	-10 to +50°C (no freezing)	
Storage/Transportation Temperature	-30 to +70°C (no freezing)	
Operating Humidity	35 to 85% RH (no condensation)	
Altitude	0 to 2000m (operation) 0 to 3000m (transportation)	
Reset Time	500 ms maximum	
Repeat Error	±0.2%, ±10 ms (Note)	
Voltage Error	±0.2%, ±30 ms (Note)	
Temperature Error	±0.2%, ±10 ms (Note)	
Setting Error	±10% maximum	
Insulation Resistance	100 MΩ minimum (500V DC megger)	
Dielectric Strength	Between power and output terminals: 2000V AC, 1 minute	
	Between contacts of different poles: 2000V AC, 1 minute	
	Between contacts of the same pole: 1000V AC, 1 minute	
Vibration Resistance	10 to 55 Hz, amplitude 0.75 mm, 2 hours each in 3 directions	
Shock Resistance	Operating extremes: 98 m/s ² , Damage limits: 490 m/s ² , 3 shocks each in 6 directions	
Degree of Protection	IP40 (timer), IP20 (socket) (IEC60529)	
Power Consumption (approx.)	GT3S-1AF20	GT3S-2AF20
	2.3VA (100V AC/60Hz) 4.0VA (200V AC/60Hz)	2.3VA (100V AC/60Hz) 3.8VA (200V AC/60Hz)
Dimensions	40H 36W 72.2D mm	
Weight (approx.)	GT3S-1AF20	GT3S-2AF20
	68g	75g

Note: The largest value becomes the error against a preset value depending on the time range.

GT3 Series [Star-Delta Type]

Operation Chart

Contact	Internal Connection	Operation Chart																							
GT3S-1 Star : Delayed SPST-NO Delta: Delayed SPST-NO		<table border="1"> <thead> <tr> <th>Item</th> <th>Terminal No.</th> <th>Operation</th> </tr> </thead> <tbody> <tr> <td>Power</td> <td>2-7</td> <td>[Power ON pulse]</td> </tr> <tr> <td>Star Delayed Contact</td> <td>8-5 (NO)</td> <td>[ON at T1, OFF at T1]</td> </tr> <tr> <td>Delta Delayed Contact</td> <td>8-6 (NO)</td> <td>[ON at T2, OFF at T3]</td> </tr> <tr> <td rowspan="2">Indicator</td> <td>Star</td> <td>[ON at T1, OFF at T1]</td> </tr> <tr> <td>Delta</td> <td>[ON at T2, OFF at T3]</td> </tr> <tr> <td>Set Time</td> <td></td> <td>[T1, T2, T3 intervals]</td> </tr> </tbody> </table> <p>The star delayed contact goes on when power is turned on and goes off after a set time for the star contact (T_1).</p> <p>The delta contact goes on after star-delta swithing time (T_2) and goes off when power is turned off.</p> <p>T_1 = Star ON time (Set Time), T_2 = Star-delta swithing time, T_3 = Star ON time</p>	Item	Terminal No.	Operation	Power	2-7	[Power ON pulse]	Star Delayed Contact	8-5 (NO)	[ON at T1, OFF at T1]	Delta Delayed Contact	8-6 (NO)	[ON at T2, OFF at T3]	Indicator	Star	[ON at T1, OFF at T1]	Delta	[ON at T2, OFF at T3]	Set Time		[T1, T2, T3 intervals]			
Item	Terminal No.	Operation																							
Power	2-7	[Power ON pulse]																							
Star Delayed Contact	8-5 (NO)	[ON at T1, OFF at T1]																							
Delta Delayed Contact	8-6 (NO)	[ON at T2, OFF at T3]																							
Indicator	Star	[ON at T1, OFF at T1]																							
	Delta	[ON at T2, OFF at T3]																							
Set Time		[T1, T2, T3 intervals]																							
GT3S-2 Star : Delayed SPST-NO Delta: Delayed SPST-NO Instantaneous SPST-NO		<table border="1"> <thead> <tr> <th>Item</th> <th>Terminal No.</th> <th>Operation</th> </tr> </thead> <tbody> <tr> <td>Power</td> <td>2-7</td> <td>[Power ON pulse]</td> </tr> <tr> <td>Star Delayed Contact</td> <td>8-5 (NO)</td> <td>[ON at T1, OFF at T1]</td> </tr> <tr> <td>Delta Delayed Contact</td> <td>8-6 (NO)</td> <td>[ON at T2, OFF at T3]</td> </tr> <tr> <td>Instantaneous contact</td> <td>3-1 (NO)</td> <td>[ON at T1, OFF at T3]</td> </tr> <tr> <td rowspan="2">Indicator</td> <td>Star</td> <td>[ON at T1, OFF at T1]</td> </tr> <tr> <td>Delta</td> <td>[ON at T2, OFF at T3]</td> </tr> <tr> <td>Set Time</td> <td></td> <td>[T1, T2, T3 intervals]</td> </tr> </tbody> </table> <p>The star delayed contact goes on when power is turned on and goes off after a set time for the star contact (T_1).</p> <p>The delta contact goes on after star-delta swithing time (T_2) and goes off when power is turned off.</p> <p>Instantaneous contact goes on when power is turned on and goes off when power is turned off.</p> <p>T_1 = Star ON time (Set Time), T_2 = Star-delta swithing time, T_3 = Star ON time</p>	Item	Terminal No.	Operation	Power	2-7	[Power ON pulse]	Star Delayed Contact	8-5 (NO)	[ON at T1, OFF at T1]	Delta Delayed Contact	8-6 (NO)	[ON at T2, OFF at T3]	Instantaneous contact	3-1 (NO)	[ON at T1, OFF at T3]	Indicator	Star	[ON at T1, OFF at T1]	Delta	[ON at T2, OFF at T3]	Set Time		[T1, T2, T3 intervals]
Item	Terminal No.	Operation																							
Power	2-7	[Power ON pulse]																							
Star Delayed Contact	8-5 (NO)	[ON at T1, OFF at T1]																							
Delta Delayed Contact	8-6 (NO)	[ON at T2, OFF at T3]																							
Instantaneous contact	3-1 (NO)	[ON at T1, OFF at T3]																							
Indicator	Star	[ON at T1, OFF at T1]																							
	Delta	[ON at T2, OFF at T3]																							
Set Time		[T1, T2, T3 intervals]																							

GT3 Series Multi-function Timers [Twin-Timer Type]

GT3W-A11, -A13, -A31, A33

Multi-range Twin-Timer type with 8 operation modes

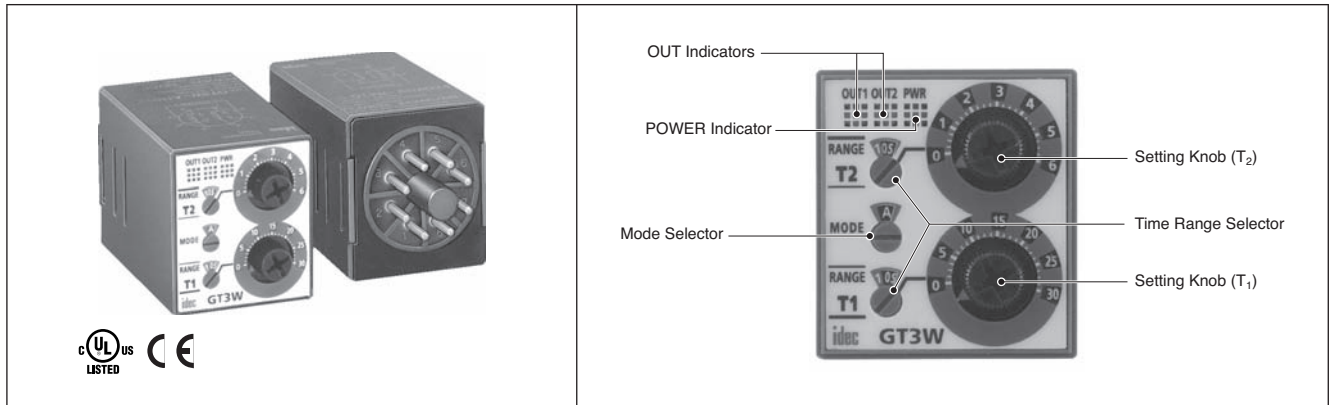

Type List

(1) Operation Mode	Rated Voltage	Time Ranges		Type No.
		T ₁	T ₂	
Sequential Start	100 to 240V AC	0.1 sec to 6 hours	0.1 sec to 6 hours	GT3W-A11AF20N
	24V AC/24V DC			GT3W-A11AD24N
Coarse/Fine Adjustment	100 to 240V AC	0.1 sec to 300 hours		GT3W-A13AF20N
	24V AC/24V DC			GT3W-A13AD24N
Instantaneous Cycle	100 to 240V AC	0.1 sec to 6 hours		GT3W-A31AF20N
	24V AC/24V DC			GT3W-A31AD24N
Cycle Inversion	100 to 240V AC	0.1 sec to 300 hours		GT3W-A33AF20N
	24V AC/24V DC			GT3W-A33AD24N
Interval ON	100 to 240V AC			
Interval ON Delay	24V AC/24V DC			
Sequential Interval	100 to 240V AC			
	24V AC/24V DC			

Time Ranges

0.1 sec to 6 hours			0.1 sec to 300 hours		
Time Range Selector	Scale	Time Range	Time Range Selector	Scale	Time Range
1S	0 - 1	0.1 sec to 1 sec	1S	0 - 3	0.1 sec to 3 sec
10S		0.3 sec to 10 sec	1M		3.8 sec to 3 min
10M	0 - 6	15 sec to 10 min	1H	0 - 30	3.8 min to 3 hours
1S		0.1 sec to 6 sec	1S		0.6 sec to 30 sec
10S		1.3 sec to 60 sec	1M		38 sec to 30 min
1M		7.5 sec to 1 min	1H		38 min to 30 hours
10M		75 sec to 60 min	10H		6.3 hours to 300 hours
1H		7.5 min to 6 hours			

Contact Ratings

Rated Load	240V AC, 3A (resistive load) 120V AC/ 30V DC, 5A (resistive load)	
Maximum Switching Power	AC: 960VA DC: 120W	
Maximum Switching Voltage	250V AC/150V DC	
Maximum Switching Current	5A	
Maximum Switching Frequency	1800 operations/hour	
Minimum Applicable Load	5V DC, 10mA (reference value)	
External Protection Element	Fuse 250V, 5A	
Life	Electrical	100,000 operations minimum (rated load)
	Mechanical	20,000,000 operations minimum

General Specifications

Operation System	Solid-state CMOS circuitry	
Operation Type	Multi-Mode	
Time Range	0.1 sec to 300 hours	
Pollution Degree	2 (IEC60664-1)	
Overvoltage Category	III (IEC60664-1)	
Rated Range	AF20	100 to 240V AC (50/60Hz)
	AD24	24V AC (50/60Hz)/ 24V DC
Voltage Range	AF20	85 to 264V AC (50/60Hz)
	AD24	20.4 to 26.4V AC (50/60Hz)/21.6 to 26.4V DC
Reset Voltage	Rated voltage 10% minimum	
Operating Temperature	-10 to +50°C (no freezing)	
Storage/Transportation Temperature	-30 to +70°C (no freezing)	
Operating Humidity	35 to 85% RH (no condensation)	
Altitude	0 to 2000m (operation) 0 to 3000m (transportation)	
Reset Time	60 ms maximum	
Repeat Error	±0.2%, ±10 ms (Note)	
Voltage Error	±0.2%, ±10 ms (Note)	
Temperature Error	±0.2%, ±10 ms (Note)	
Setting Error	±10% maximum	
Insulation Resistance	100 MΩ minimum (500V DC megger)	
Dielectric Strength	Between power and output terminals: 2000V AC, 1 minute	
	Between contacts of different poles: 2000V AC, 1 minute Between contacts of the same pole: 750V AC, 1 minute	
Vibration Resistance	10 to 55Hz, amplitude 0.75 mm, 2 hours each in 3 directions	
Shock Resistance	Operating extremes: 98 m/s ² Damage limits: 490 m/s ² 3 shocks each in 6 directions	
Degree of Protection	IP40 (timer), IP20 (socket) (IEC60529)	
Power Consumption (approx.)	AF20	2.3VA (100V AC /60Hz) 4.6VA (200V AC /60Hz)
	AD24	1.8VA (AC)/0.9W (DC)
Dimensions	40H 36W 70.0D mm	
Weight (approx.)	73g	

Note: The largest value becomes the error against a preset value depending on the time range.

GT3 Series Multi-function Timers [Twin-Timer Type]

Operation Chart

Operation Chart																									
Contact	Delayed SPDT + Delayed SPDT																								
Internal Connection																									
Operation Mode Selection																									
A Sequential Start	<table border="1"> <thead> <tr> <th>Item</th> <th>Terminal No.</th> <th>Operation</th> <th>Description</th> </tr> </thead> <tbody> <tr> <td>Power</td> <td>2-7</td> <td>[Pulse]</td> <td></td> </tr> <tr> <td>Delayed Contact Ry1</td> <td>1-4 (NC) 1-3 (NO)</td> <td>[Pulse]</td> <td>ON after T1</td> </tr> <tr> <td>Delayed Contact Ry2</td> <td>5-8 (NC) 6-8 (NO)</td> <td>[Pulse]</td> <td>ON after T1 + T2</td> </tr> <tr> <td>Indicator</td> <td>OUT1 OUT2</td> <td>[Pulse]</td> <td></td> </tr> <tr> <td>Set Time</td> <td></td> <td>T1 T2</td> <td></td> </tr> </tbody> </table>	Item	Terminal No.	Operation	Description	Power	2-7	[Pulse]		Delayed Contact Ry1	1-4 (NC) 1-3 (NO)	[Pulse]	ON after T1	Delayed Contact Ry2	5-8 (NC) 6-8 (NO)	[Pulse]	ON after T1 + T2	Indicator	OUT1 OUT2	[Pulse]		Set Time		T1 T2	
Item	Terminal No.	Operation	Description																						
Power	2-7	[Pulse]																							
Delayed Contact Ry1	1-4 (NC) 1-3 (NO)	[Pulse]	ON after T1																						
Delayed Contact Ry2	5-8 (NC) 6-8 (NO)	[Pulse]	ON after T1 + T2																						
Indicator	OUT1 OUT2	[Pulse]																							
Set Time		T1 T2																							
B Coarse/Fine Adjustment	<table border="1"> <thead> <tr> <th>Item</th> <th>Terminal No.</th> <th>Operation</th> <th>Description</th> </tr> </thead> <tbody> <tr> <td>Power</td> <td>2-7</td> <td>[Pulse]</td> <td></td> </tr> <tr> <td>Delayed Contact Ry1</td> <td>1-4 (NC) 1-3 (NO)</td> <td>[Pulse]</td> <td>ON after T1 + T2</td> </tr> <tr> <td>Delayed Contact Ry2</td> <td>5-8 (NC) 6-8 (NO)</td> <td>[Pulse]</td> <td>ON after T1 + T2</td> </tr> <tr> <td>Indicator</td> <td>OUT1 OUT2</td> <td>[Pulse]</td> <td></td> </tr> <tr> <td>Set Time</td> <td></td> <td>T1 T2</td> <td></td> </tr> </tbody> </table>	Item	Terminal No.	Operation	Description	Power	2-7	[Pulse]		Delayed Contact Ry1	1-4 (NC) 1-3 (NO)	[Pulse]	ON after T1 + T2	Delayed Contact Ry2	5-8 (NC) 6-8 (NO)	[Pulse]	ON after T1 + T2	Indicator	OUT1 OUT2	[Pulse]		Set Time		T1 T2	
Item	Terminal No.	Operation	Description																						
Power	2-7	[Pulse]																							
Delayed Contact Ry1	1-4 (NC) 1-3 (NO)	[Pulse]	ON after T1 + T2																						
Delayed Contact Ry2	5-8 (NC) 6-8 (NO)	[Pulse]	ON after T1 + T2																						
Indicator	OUT1 OUT2	[Pulse]																							
Set Time		T1 T2																							
C Instantaneous Cycle	<table border="1"> <thead> <tr> <th>Item</th> <th>Terminal No.</th> <th>Operation</th> <th>Description</th> </tr> </thead> <tbody> <tr> <td>Power</td> <td>2-7</td> <td>[Pulse]</td> <td></td> </tr> <tr> <td>Delayed Contact Ry1</td> <td>1-4 (NC) 1-3 (NO)</td> <td>[Pulse]</td> <td>Instantaneous ON</td> </tr> <tr> <td>Delayed Contact Ry2</td> <td>5-8 (NC) 6-8 (NO)</td> <td>[Pulse]</td> <td>OFF during T1 ON during T2</td> </tr> <tr> <td>Indicator</td> <td>OUT1 OUT2</td> <td>[Pulse]</td> <td></td> </tr> <tr> <td>Set Time</td> <td></td> <td>T1 T2</td> <td></td> </tr> </tbody> </table>	Item	Terminal No.	Operation	Description	Power	2-7	[Pulse]		Delayed Contact Ry1	1-4 (NC) 1-3 (NO)	[Pulse]	Instantaneous ON	Delayed Contact Ry2	5-8 (NC) 6-8 (NO)	[Pulse]	OFF during T1 ON during T2	Indicator	OUT1 OUT2	[Pulse]		Set Time		T1 T2	
Item	Terminal No.	Operation	Description																						
Power	2-7	[Pulse]																							
Delayed Contact Ry1	1-4 (NC) 1-3 (NO)	[Pulse]	Instantaneous ON																						
Delayed Contact Ry2	5-8 (NC) 6-8 (NO)	[Pulse]	OFF during T1 ON during T2																						
Indicator	OUT1 OUT2	[Pulse]																							
Set Time		T1 T2																							
D Cycle	<table border="1"> <thead> <tr> <th>Item</th> <th>Terminal No.</th> <th>Operation</th> <th>Description</th> </tr> </thead> <tbody> <tr> <td>Power</td> <td>2-7</td> <td>[Pulse]</td> <td></td> </tr> <tr> <td>Delayed Contact Ry1</td> <td>1-4 (NC) 1-3 (NO)</td> <td>[Pulse]</td> <td>OFF during T1 ON during T2</td> </tr> <tr> <td>Delayed Contact Ry2</td> <td>5-8 (NC) 6-8 (NO)</td> <td>[Pulse]</td> <td>OFF during T1 ON during T2</td> </tr> <tr> <td>Indicator</td> <td>OUT1 OUT2</td> <td>[Pulse]</td> <td></td> </tr> <tr> <td>Set Time</td> <td></td> <td>T1 T2</td> <td></td> </tr> </tbody> </table>	Item	Terminal No.	Operation	Description	Power	2-7	[Pulse]		Delayed Contact Ry1	1-4 (NC) 1-3 (NO)	[Pulse]	OFF during T1 ON during T2	Delayed Contact Ry2	5-8 (NC) 6-8 (NO)	[Pulse]	OFF during T1 ON during T2	Indicator	OUT1 OUT2	[Pulse]		Set Time		T1 T2	
Item	Terminal No.	Operation	Description																						
Power	2-7	[Pulse]																							
Delayed Contact Ry1	1-4 (NC) 1-3 (NO)	[Pulse]	OFF during T1 ON during T2																						
Delayed Contact Ry2	5-8 (NC) 6-8 (NO)	[Pulse]	OFF during T1 ON during T2																						
Indicator	OUT1 OUT2	[Pulse]																							
Set Time		T1 T2																							

Operation Chart																									
Contact	Delayed SPDT + Delayed SPDT																								
Internal Connection																									
Operation Mode Selection																									
E Cycle Inversion	<table border="1"> <thead> <tr> <th>Item</th> <th>Terminal No.</th> <th>Operation</th> <th>Description</th> </tr> </thead> <tbody> <tr> <td>Power</td> <td>2-7</td> <td>[Pulse]</td> <td></td> </tr> <tr> <td>Delayed Contact Ry1</td> <td>1-4 (NC) 1-3 (NO)</td> <td>[Pulse]</td> <td>ON during T1 OFF during T2</td> </tr> <tr> <td>Delayed Contact Ry2</td> <td>5-8 (NC) 6-8 (NO)</td> <td>[Pulse]</td> <td>ON during T1 OFF during T2</td> </tr> <tr> <td>Indicator</td> <td>OUT1 OUT2</td> <td>[Pulse]</td> <td></td> </tr> <tr> <td>Set Time</td> <td></td> <td>T1 T2</td> <td></td> </tr> </tbody> </table>	Item	Terminal No.	Operation	Description	Power	2-7	[Pulse]		Delayed Contact Ry1	1-4 (NC) 1-3 (NO)	[Pulse]	ON during T1 OFF during T2	Delayed Contact Ry2	5-8 (NC) 6-8 (NO)	[Pulse]	ON during T1 OFF during T2	Indicator	OUT1 OUT2	[Pulse]		Set Time		T1 T2	
Item	Terminal No.	Operation	Description																						
Power	2-7	[Pulse]																							
Delayed Contact Ry1	1-4 (NC) 1-3 (NO)	[Pulse]	ON during T1 OFF during T2																						
Delayed Contact Ry2	5-8 (NC) 6-8 (NO)	[Pulse]	ON during T1 OFF during T2																						
Indicator	OUT1 OUT2	[Pulse]																							
Set Time		T1 T2																							
F Interval ON	<table border="1"> <thead> <tr> <th>Item</th> <th>Terminal No.</th> <th>Operation</th> <th>Description</th> </tr> </thead> <tbody> <tr> <td>Power</td> <td>2-7</td> <td>[Pulse]</td> <td></td> </tr> <tr> <td>Delayed Contact Ry1</td> <td>1-4 (NC) 1-3 (NO)</td> <td>[Pulse]</td> <td>ON during T1</td> </tr> <tr> <td>Delayed Contact Ry2</td> <td>5-8 (NC) 6-8 (NO)</td> <td>[Pulse]</td> <td>ON after T1, during T2</td> </tr> <tr> <td>Indicator</td> <td>OUT1 OUT2</td> <td>[Pulse]</td> <td></td> </tr> <tr> <td>Set Time</td> <td></td> <td>T1 T2</td> <td></td> </tr> </tbody> </table>	Item	Terminal No.	Operation	Description	Power	2-7	[Pulse]		Delayed Contact Ry1	1-4 (NC) 1-3 (NO)	[Pulse]	ON during T1	Delayed Contact Ry2	5-8 (NC) 6-8 (NO)	[Pulse]	ON after T1, during T2	Indicator	OUT1 OUT2	[Pulse]		Set Time		T1 T2	
Item	Terminal No.	Operation	Description																						
Power	2-7	[Pulse]																							
Delayed Contact Ry1	1-4 (NC) 1-3 (NO)	[Pulse]	ON during T1																						
Delayed Contact Ry2	5-8 (NC) 6-8 (NO)	[Pulse]	ON after T1, during T2																						
Indicator	OUT1 OUT2	[Pulse]																							
Set Time		T1 T2																							
G Interval ON Delay	<table border="1"> <thead> <tr> <th>Item</th> <th>Terminal No.</th> <th>Operation</th> <th>Description</th> </tr> </thead> <tbody> <tr> <td>Power</td> <td>2-7</td> <td>[Pulse]</td> <td></td> </tr> <tr> <td>Delayed Contact Ry1</td> <td>1-4 (NC) 1-3 (NO)</td> <td>[Pulse]</td> <td>ON during T1</td> </tr> <tr> <td>Delayed Contact Ry2</td> <td>5-8 (NC) 6-8 (NO)</td> <td>[Pulse]</td> <td>ON after T1 + T2</td> </tr> <tr> <td>Indicator</td> <td>OUT1 OUT2</td> <td>[Pulse]</td> <td></td> </tr> <tr> <td>Set Time</td> <td></td> <td>T1 T2</td> <td></td> </tr> </tbody> </table>	Item	Terminal No.	Operation	Description	Power	2-7	[Pulse]		Delayed Contact Ry1	1-4 (NC) 1-3 (NO)	[Pulse]	ON during T1	Delayed Contact Ry2	5-8 (NC) 6-8 (NO)	[Pulse]	ON after T1 + T2	Indicator	OUT1 OUT2	[Pulse]		Set Time		T1 T2	
Item	Terminal No.	Operation	Description																						
Power	2-7	[Pulse]																							
Delayed Contact Ry1	1-4 (NC) 1-3 (NO)	[Pulse]	ON during T1																						
Delayed Contact Ry2	5-8 (NC) 6-8 (NO)	[Pulse]	ON after T1 + T2																						
Indicator	OUT1 OUT2	[Pulse]																							
Set Time		T1 T2																							
H Sequential Interval	<table border="1"> <thead> <tr> <th>Item</th> <th>Terminal No.</th> <th>Operation</th> <th>Description</th> </tr> </thead> <tbody> <tr> <td>Power</td> <td>2-7</td> <td>[Pulse]</td> <td></td> </tr> <tr> <td>Delayed Contact Ry1</td> <td>1-4 (NC) 1-3 (NO)</td> <td>[Pulse]</td> <td>ON during T1 + T2</td> </tr> <tr> <td>Delayed Contact Ry2</td> <td>5-8 (NC) 6-8 (NO)</td> <td>[Pulse]</td> <td>ON after T1, during T2</td> </tr> <tr> <td>Indicator</td> <td>OUT1 OUT2</td> <td>[Pulse]</td> <td></td> </tr> <tr> <td>Set Time</td> <td></td> <td>T1 T2</td> <td></td> </tr> </tbody> </table>	Item	Terminal No.	Operation	Description	Power	2-7	[Pulse]		Delayed Contact Ry1	1-4 (NC) 1-3 (NO)	[Pulse]	ON during T1 + T2	Delayed Contact Ry2	5-8 (NC) 6-8 (NO)	[Pulse]	ON after T1, during T2	Indicator	OUT1 OUT2	[Pulse]		Set Time		T1 T2	
Item	Terminal No.	Operation	Description																						
Power	2-7	[Pulse]																							
Delayed Contact Ry1	1-4 (NC) 1-3 (NO)	[Pulse]	ON during T1 + T2																						
Delayed Contact Ry2	5-8 (NC) 6-8 (NO)	[Pulse]	ON after T1, during T2																						
Indicator	OUT1 OUT2	[Pulse]																							
Set Time		T1 T2																							

Applicable Sockets & Hold-Down Springs (Optional)

DIN Rail Mount Socket

Item		Type No.	Ordering Type No.	Package Quantity	Remarks
Socket	8-Pin Screw Terminal	SR2P-05A	SR2P-05A	1	
		SR2P-06A	SR2P-06A	1	
		SR2P-05C	SR2P-05C	1	Finger-safe type
	11-Pin Screw Terminal	SR3P-05A	SR3P-05A	1	
		SR3P-06A	SR3P-06A	1	
		SR3P-05C	SR3P-05C	1	Finger-safe type
Hold-Down Spring		SFA-202	SFA-202PN20	10 sets (20 pcs)	For SR2P-06A/SR3P-06A (2 pcs/set)
		SFA-203	SFA-203PN20	10 sets (20 pcs)	For SR3P-05A (2 pcs/set)

Note: All are UL recognized, CSA certified, and TÜV approved.



Panel Mount Socket

Item		Type No.	Ordering Type No.	Package Quantity	Remarks
Socket	8-Pin Solder Terminal	SR2P-511	SR2P-511	1	
	11-Pin Solder Terminal	SR3P-511	SR3P-511	1	
Hold-Down Spring		SFA-402	SFA-402PN10	10	For SR2P-511/SR3P-511

Note: SR2P-511 and SR3P-511 are UL recognized and CSA certified.



Panel Mount Adapter and wiring Socket Adapter

Item		Type No.
DIN 48mm Square Panel Mount Adapter	Color: Gray	RTB-G01
	Color: Beige	RTB-M01
	Color: Black	RTB-B01
Wiring Socket Adapter	8-Pin Solder Terminal	SR6P-S08
	8-Pin Screw Terminal	SR6P-M08G
	11-Pin Solder Terminal	SR6P-S11
	11-Pin Screw Terminal	SR6P-M11G

Package Quantity: 1

(8-pin Wiring Socket Adapter)
SR6P-S08



(8-pin Screw Wiring Socket Adapter)
SR6P-M08G



(11-pin Wiring Socket Adapter)
SR6P-S11



(11-pin Screw Wiring Socket Adapter)
SR6P-M11G



Finger-safe 11-pin screw wiring socket adapter (Type No.: SR6P-C11) is also available.

Installation of Hold-Down Springs

(DIN Rail Mount Socket)

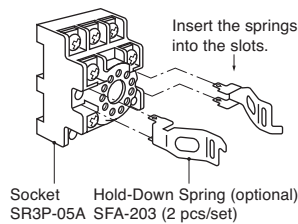
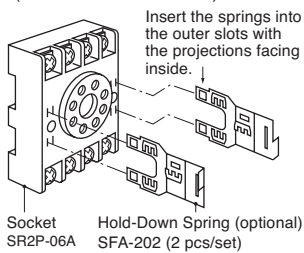

(Panel Mount Socket)

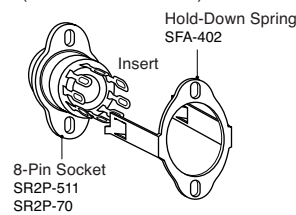

Note: Once installed into the socket, the hold-down springs cannot be removed.

Flush Silhouette

Control Units

Display Lights

Display Units

Safety Products

Terminal Blocks

Comm. Terminals

AS-Interface

Relays & Timers

Sockets

Circuit Protectors

Power Supplies

PLCs & SmartRelay

Operator Interfaces

Sensors

Control Stations

Explosion Protection

References

GT3 Series Multi-function Timers [All]

Dimensions

When Using DIN Rail Mount Socket
(SR2P-06A Socket)

GT3A-1, -2, -3/GT3F/GT3S (8-pin)

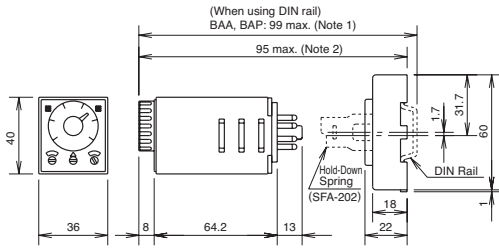

Note 1: For SR2P-05A: 105.5 max.
For SR2P-05C: 107 max.
Note 2: For SR2P-05A: 101.5 max.
For SR2P-05C: 103 max.

GT3W

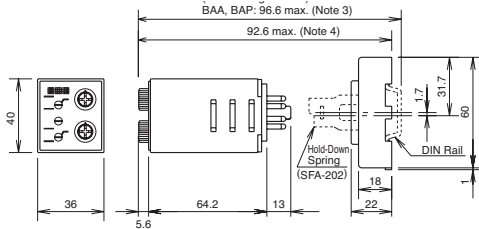

Note 3: For SR2P-05A: 103.1 max.
For SR2P-05C: 104.6 max.
Note 4: For SR2P-05A: 99.1 max.
For SR2P-05C: 100.6 max.

[Internal Connections]

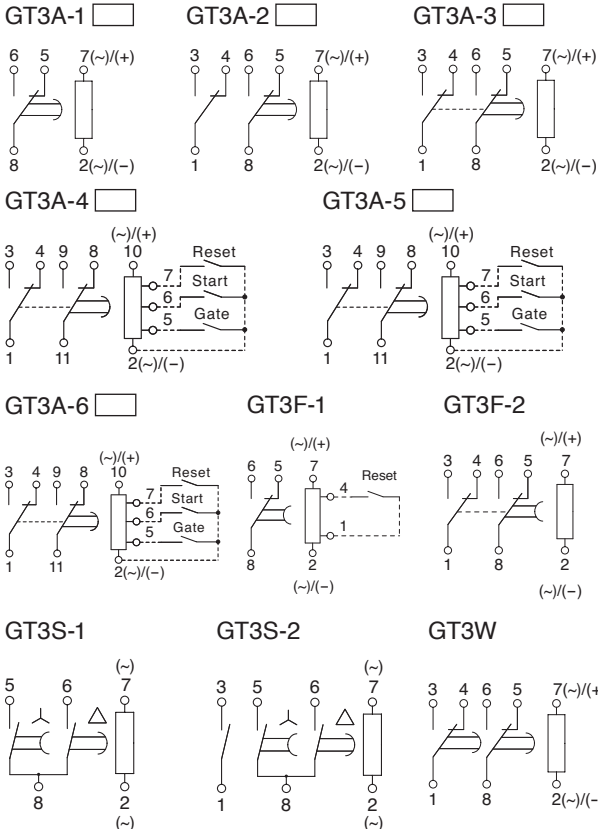

GT3A-4, -5, -6 (11-pin)
(SR3P-05A Socket)

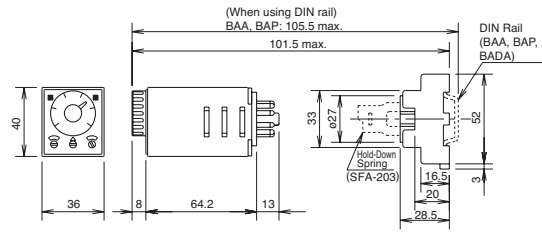

(SR3P-05C Socket)

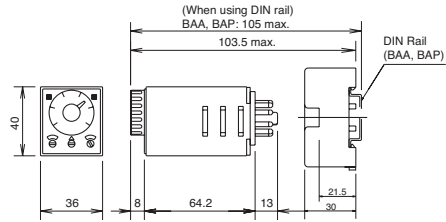

(SR3P-06A Socket)

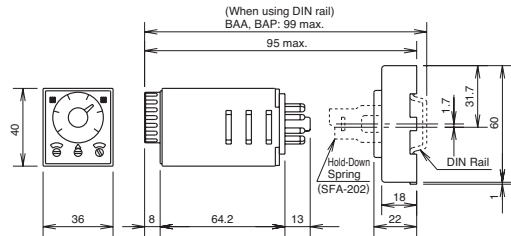

Calculate the dimensions for mounting, referring to the diagrams on pages 1109 and 1100 for SR2P-05U, SR2P-05C, and SR3P-05C.

When Using Panel Mount Socket

GT3A-1, -2, -3/GT3F/GT3S/GT3W (8-pin)
(SR2P-511 Socket)

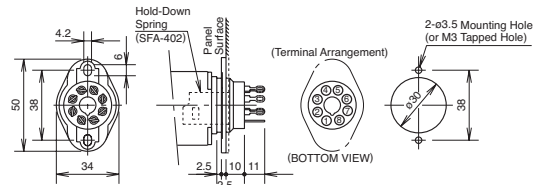

GT3A-4, -5, -6
(SR3P-511 Socket)

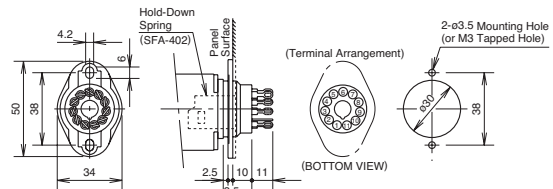

All dimensions in mm.

GT3 Series Multi-function Timers [All]

All GT3 Series

When using DIN 48mm-square Panel Mount Adapter

(For 8-pin solder wiring socket adapter: SR6P-S08 and 11-pin solder wiring socket adapter: SR6P-S11)

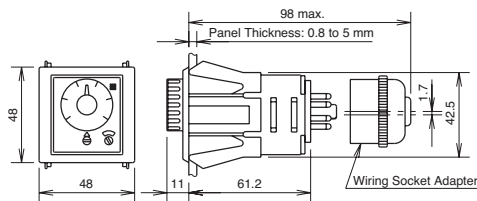

(Mounting Hole Layout)

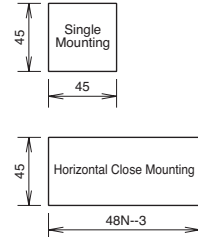

Tolerance: +0.5 to 0
N: No. of timers mounted

(8-pin Screw Terminal Wiring Socket Adapter: SR6P-M08G)

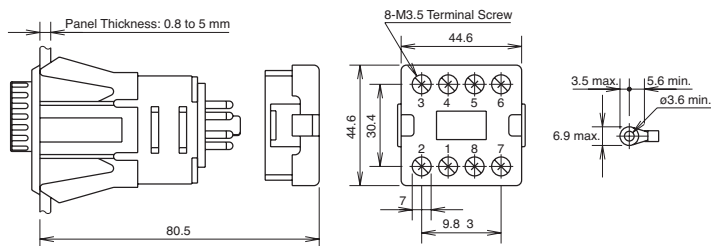

(11-pin Screw Terminal Wiring Socket Adapter: SR6P-M11G)

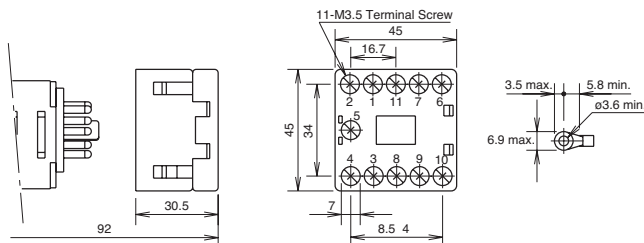

(Finger-safe 11-pin Screw Terminal Wiring Socket Adapter: SR6P-C11)

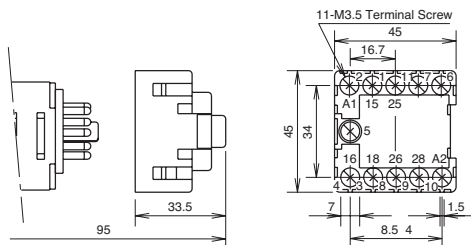

Finger-safe structure complies with VDE 0106 T.100.

All dimensions in mm.

Flush Silhouette
Control Units
Display Lights
Display Units
Safety Products
Terminal Blocks
Comm. Terminals
AS-Interface
Relays & Timers
Sockets
Circuit Protectors
Power Supplies
PLCs & SmartRelay
Operator Interfaces
Sensors
Control Stations
Explosion Protection
References

GT3 Series Multi-function Timers [Safety Precautions and Instructions]

⚠ Safety Precautions

Be sure to turn off power before mounting, removal, wiring, maintenance and inspection. Otherwise, electric shock or fire may occur.
 Be sure to use timers within rated specification values. Otherwise electric shock or fire may occur.

Be sure to use wires to meet voltage and current requirements and tighten M3.5 terminal screws to a torque of 1.0 to 1.3 N·m. Be sure to solder the terminals correctly. Loose terminal screws or incomplete soldering may cause abnormal heat and fire.

Instructions

Mode Setting

GT3A only

The operation mode can be selected from A, B, C, and D modes using the Operation Mode Selector. The operation mode is changed from A to B, C, and D in turn by turning the Operation Mode Selector clockwise using a flat screwdriver 4 mm wide maximum and the selected mode is displayed in the window. Since this selector does not turn infinitely, turn the selector clockwise when Mode A is displayed and counterclockwise when Mode D is displayed.

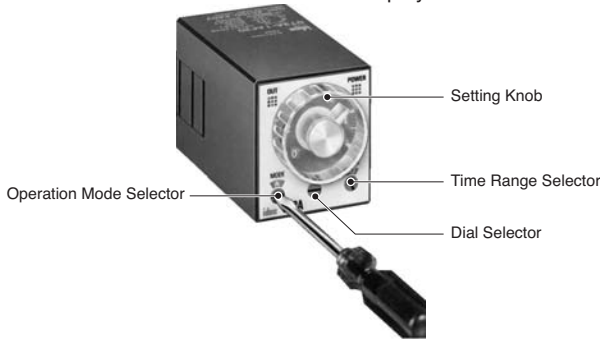

Mode Code and Operation Mode

MODE Code	Type No.	GT3A-1, -2, -3	GT3A-4	GT3A-5	GT3A-6
	A	ON Delay	ON Delay	Interval ON	One-Shot
B	Interval ON	Cycle	One Shot Cycle	One-Shot ON Delay	
C	Cycle	Signal ON/OFF Delay	Signal ON/OFF Delay	One-Shot	
D	Cycle ON	Signal OFF Delay	Signal OFF Delay	Signal ON/OFF Delay	

Time Range Setting

The time range is calibrated at its maximum time scale, therefore, it is desirable to use the timer at a setting as close to its maximum time scale as possible for accurate time delay. For a more accurate time delay, adjust the setting knob by measuring the operating time before application.

1. GT3A (Multi-Mode Analog Setting Type)

Time range can be selected from 1S, 10S, 10M, and 10H by turning the Time Range Selector with a flat screwdriver 4 mm wide maximum. The four different ranges of 0 to 1, 0 to 3, 0 to 6, and 0 to 18 are displayed in the six windows by turning the Dial Selector, allowing for selecting the best suited scale. Since the selectors do not turn infinitely, turn the selectors clockwise when 1S or 0-1 is displayed and counterclockwise when 10H or 0-18 is displayed.

Time Range Determined by Time Range Selector and Dial Selector

Time Range	Dial Selector	0 - 1	0 - 3	0 - 6	0 - 18
	1S		0.1 sec to 1 sec	0.1 sec to 3 sec	0.1 sec to 6 sec
10S		0.1 sec to 10 sec	0.3 sec to 30 sec	0.6 sec to 60 sec	1.8 sec to 180 sec
10M		6 sec to 10 min	18 sec to 30 min	36 sec to 60 min	108 sec to 180 min
10H		6 min to 10 hours	18 min to 30 hours	36 min to 60 hours	108 min to 180 hours

The set time is selected by turning the setting knob.

[Setting Examples]

When the setting knob is set at 1.5, with dial 0-3 and time range 10S selected, then the set time is 15 sec (1.5 × 10S).
 When the setting knob is set at 0.2, with dial 0-1 and time range 10H selected, then the set time is 2 hours (0.2 × 10H).

2. GT3F (OFF Delay Type)

The time range of GT3F-1 and GT3F-2 can be selected between 1S and 10S with the Time Range Selector by using a flat screw driver. The selected time range (0-1, 0-3, 0-18, or 0-60) is displayed in the six windows of the Setting Knob by turning Dial Selector which allows to set the scale. Note that the switches do not turn infinitely.

Time Range Determined by Time Range Selector and Dial Selector

(2) Range	(1) Dial	0 - 1	0 - 3	0 - 18	0 - 60
	1S		0.1 sec to 1 sec	0.1 sec to 3 sec	0.2 sec to 18 sec
10S		0.1 sec to 10 sec	0.3 sec to 30 sec	1.8 sec to 180 sec	6 sec to 600 sec

The set time is selected by turning the Setting Knob.

[Setting Examples]

When the setting knob is set at 2.5, with dial 0-3 and range 1S selected, then the set time is 2.5 sec (2.5 × 1S).
 When the setting knob is set at 15, with dial 0-18 and range 10S selected, then the set time is 150 sec (15 × 10S).

3. GT3S (Star-Delta Type)



The scale range on the star side can be selected from four different ranges of 0 to 5, 0 to 10, 0 to 50, and 0 to 100 displayed in the six windows by turning the Star Dial Selector. Note that the selectors does not turn infinitely.

Time Range Determined by Time Range Selector and Dial Selector

Star Dial Selector		Star-Delta Switching Time Selector	
Dial	Time Range	Indication	Time
0 - 5	0.05 sec - 5 sec	0.05	0.05 sec
0 - 10	0.1 sec - 10 sec	0.1	0.1 sec
0 - 50	0.3 sec - 50 sec	0.25	0.25 sec
0 - 100	1 sec - 100 sec	0.5	0.5 sec

The Star ON time is selected by turning the Setting Knob.

[Setting Examples]

If the setting knob is set at 8, with Star Dial Selector 0-10 and Star-Delta switching time 0.1S selected, the Star ON time (T_1) is 8 sec and the Star-Delta switching time (T_2) is 0.1 sec.

4. GT3W [Twin-Timer Type]

Use a flat screwdriver with a diameter of 4 mm maximum to turn Time Range Selector and gain time range as shown in the table below. Note that the selectors do not turn infinitely.

Time Range Determined by Time Range Selector and Dial Selector

0.1 sec to 6 hours			0.1 sec to 300 hours		
Time Range Selector	Scale	Time Range	Time Range Selector	Scale	Time Range
1S	0 - 1	0.1 sec to 1 sec	1S	0 - 3	0.1 sec to 3 sec
10S		0.3 sec to 10 sec	1M		3.8 sec to 3 min
10M		15 sec to 10 min	1H		3.8 min to 3 hours
1S	0 - 6	0.1 sec to 6 sec	1S	0 - 30	0.6 sec to 30 sec
10S		1.3 sec to 60 sec	1M		38 sec to 30 min
1M		7.5 sec to 1 min	1H		38 min to 30 hours
10M		75 sec to 60 min	10H		6.3 hours to 300 hours
1H		7.5 min to 6 hours			

Note: No blank time range can be set.



Selector Setting

Use a flat screwdriver with a diameter of 4 mm maximum to turn the selector. Turn the selector until it clicks. Otherwise, malfunction may occur. Also, do not rotate the selector forcibly since the selector does not turn infinitely. Since changing the setting during operation may cause malfunction, turn power off before changing the setting.

Power

Since DC types have a polarity in their power supply connection, connect the power according to wiring diagram. Since AC type GT3A, GT3S, and GT3W comprise a capacitive load, the SSR dielectric strength should be two or more times as large as the power voltage when switching the timer power using an SSR.

Storage temperature should range from -25°C to $+80^{\circ}\text{C}$. If the product has been stored at a temperature below -10°C , leave the product at room temperatures for more than 3 hours before using.

Do not remove the housing.

Flush Silhouette
Control Units
Display Lights
Display Units
Safety Products
Terminal Blocks
Comm. Terminals
AS-Interface
Relays & Timers
Sockets
Circuit Protectors
Power Supplies
PLCs & SmartRelay
Operator Interfaces
Sensors
Control Stations
Explosion Protection
References

GT3 Series Multi-function Timers [Instructions]

Wiring

The GT3F, consisting of a high-impedance circuit, may not be reset due to the influence of an inductive voltage or residual voltage caused by a leakage current. In not reset, connect an RC filter or bleeder resistor between power terminals so that the voltage between power terminals can be reduced to less than 15% of the rated voltage.

Inputs of GT3A and GT3F

To avoid electric shock, do not touch the input signal terminal during power voltage application.

When connecting the input signal terminals of two or more GT3A timers to the same contact or transistor, the input terminals of the same number should be connected. (Connect Terminals No. 2 in common.)

Never apply the input signals to two or more GT3F timers using the same contact or transistor.

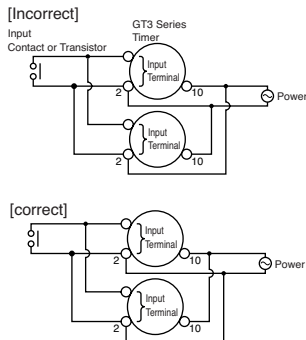

In a transistor circuit for controlling input signals with its primary and secondary power circuits isolated, do not ground the secondary circuit.

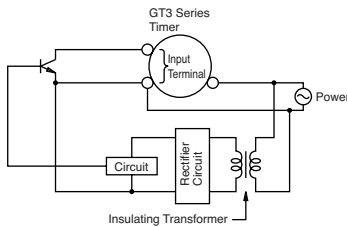

Do not connect input signal terminals of the GT3A timer to other terminals than No. 2. Never apply voltage to input signal terminals. Otherwise, the internal circuit may be damaged.

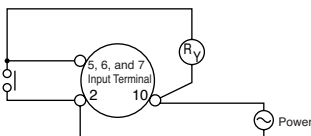

Do not connect input signal terminals of the GT3F timer to other terminals than No. 2. Never apply voltage to input signal terminals. Otherwise, the internal circuit may be damaged.

Input signal lines must be made as short as possible and installed away from power cables and power lines. Shielded wires or a separate conduit should be used for input wiring.

For contact input, use reliable gold-plated contacts to make sure that the residual voltage is less than 1V when the contacts are closed.

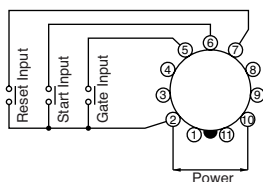

For transistor input, use transistors with following specifications; $V_{CE} = 40V$, $V_{CES} = 1V$ or less, $I_C = 50mA$ or more, $I_{CBO} = 50\mu A$ or less. The resistance should be less than $1k\Omega$ when the transistor is on. When the output transistor switches on, a signal is inputted to the timer.

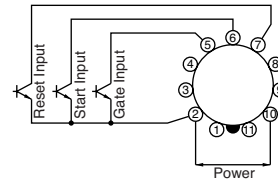

GT3A

Transistor output equipment such as proximity switches and photoelectric switches can input signals if they are voltage/current output type, power voltage ranges from 18 to 30V, and residual voltage is 1V. When the signal voltage switches from H to L, a signal is inputted to the timer.

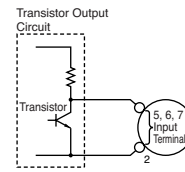

GT3F

Do not input signals using transistor output equipment of a voltage/current output type. Otherwise, the internal circuit may be damaged.

Minimum Power Application Time

If the power application time to the GT3F is shorter than the minimum power application time, the output relay may not operate or the timer may operate faster than the preset time.

Time Accuracy

Repeat Error

This indicates variance of operation time when operation is repeated under the same conditions. The variance is calculated from the following formula and the measurements should be done 5 times at least.

$$= \pm \frac{1}{2} \frac{\text{Max. measured value} - \text{Min. measured value}}{\text{Maximum scale value}} 100 (\%)$$

Voltage Error

This indicates the variance of operation time when the voltage at operation current varies within allowable voltage variance.

$$= \pm \frac{T_v - T_r}{T_r} 100 (\%)$$

T_v : Average of measured operation time values at voltage V

T_r : Average of measured operation time values at the rated voltage

Temperature Error

This indicates the influence caused by the change in temperature during operation within operating temperature. This is shown with the variance of operation time.

$$= \pm \frac{T_t - T_{20}}{T_{20}} \times 100 (\%)$$

Tt: Average of operation times at temperature t

T₂₀: Average of operation times at reference temperature (20°C)

Setting Error

This indicates the gap between actual operation time and that on scale. Calculated from below formula, this is measured at any point but more than one-third of the maximum scale value.

$$= \pm \frac{\text{Average of measured values} - \text{Set value}}{\text{Maximum scale value}} \times 100 (\%)$$

Load Current

The rated current of the contact (or control output) should not be exceeded. Especially for inductive, capacitive, and incandescent lamp loads, the inrush current as large as a few to several tens times the rated current may cause welded contacts and other troubles. The amount of inrush current as well as steady-state current must be taken into consideration.

Contact Protection

Switching an inductive load generates a counter-electromotive force in the coil. The counter emf will cause arcing, which may shorten the contact life. Application of a protection circuit is recommended for contact protection.

Rest Time

When turning power off after time-out or during operation, allow a rest time longer than the reset time to restart. (Each model has a different reset time.)

Continuous Energizing

Continuous energizing for a long period of time may damage the electrical characteristics of the timer because of internal heating. Use an additional relay to the output circuit and refrain from continuous energizing of the timer.

Dielectric Strength Test

When performing an insulation resistance or dielectric-strength test on control panels containing timers, make sure that the dielectric strength of the timer is not exceeded. In case the dielectric strength is exceeded, remove the timers from the panels.

Operating Environment

Temperature and Humidity

Use the timer within the operating temperature and operating humidity ranges and prevent freezing and condensation. After storing below the operation temperature, leave the timer at room temperature for a sufficient period of time before use.

Environment

Prevent a corrosive gas such as sulfurous or ammonia gas, organic solvents (alcohol, benzine, thinner, etc.), strong alkaline substances or strong acids from touching to the timer, and do not use the timer in such an environment. Keep the timer from water splashes or steam.

Vibration and Shock

Since excessive vibrations or shocks cause the output contacts to open, the timer should be used within the operating extremes of vibration and shock resistance. Use of hold-down springs is recommended for secure mounting on sockets.

Noise and Static Charge

Check the operation of the timer before using in an environment with a lot of noise. Install the input signal source, input signal wiring and timer away from noise source and high-voltage wire with noise as much as possible. Also, in case of using the timer under the environment with multiple static charge (pipe transportation of molding material, power/liquid material, etc.), place the timer away from such static charge source as well.

Others

The GT3F does not read the preset values of each selector after power is turned off. Note that minimizing the preset time does not shorten the delay time after power is turned off.

To make a sequence circuit by connecting timers and relays, check the timer operation sufficiently in consideration of the reset time of the timer.

Flush Silhouette
Control Units
Display Lights
Display Units
Safety Products
Terminal Blocks
Comm. Terminals
AS-Interface
Relays & Timers
Sockets
Circuit Protectors
Power Supplies
PLCs & SmartRelay
Operator Interfaces
Sensors
Control Stations
Explosion Protection
References