



Green Premium™

An industry leading portfolio of offers delivering sustainable value



More than 75% of our product sales offer superior transparency on the material content, regulatory information and environmental impact of our products:

- RoHS compliance
- REACH substance information
- Industry leading # of PEP's*
- Circularity instructions



Discover what we mean by green
Check your products!

The Green Premium program stands for our commitment to deliver customer valued sustainable performance. It has been upgraded with recognized environmental claims and extended to cover all offers including Products, Services and Solutions.

CO₂ and P&L impact through... [Resource Performance](#)

Green Premium brings improved resource efficiency throughout an asset's lifecycle. This includes efficient use of energy and natural resources, along with the minimization of CO₂ emissions.

Cost of ownership optimization through... [Circular Performance](#)

We're helping our customers optimize the total cost of ownership of their assets. To do this, we provide IoT-enabled solutions, as well as upgrade, repair, retrofit, and remanufacture services.

Peace of mind through... [Well-being Performance](#)

Green Premium products are RoHS and REACH compliant. We're going beyond regulatory compliance with step-by-step substitution of certain materials and substances from our products.

Improved sales through... [Differentiation](#)

Green Premium delivers strong value propositions through third-party labels and services. By collaborating with third-party organizations we can support our customers in meeting their sustainability goals such as green building certifications.

*PEP: Product Environmental Profile (i.e. Environmental Product Declaration)

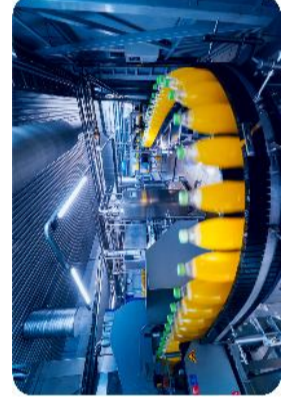
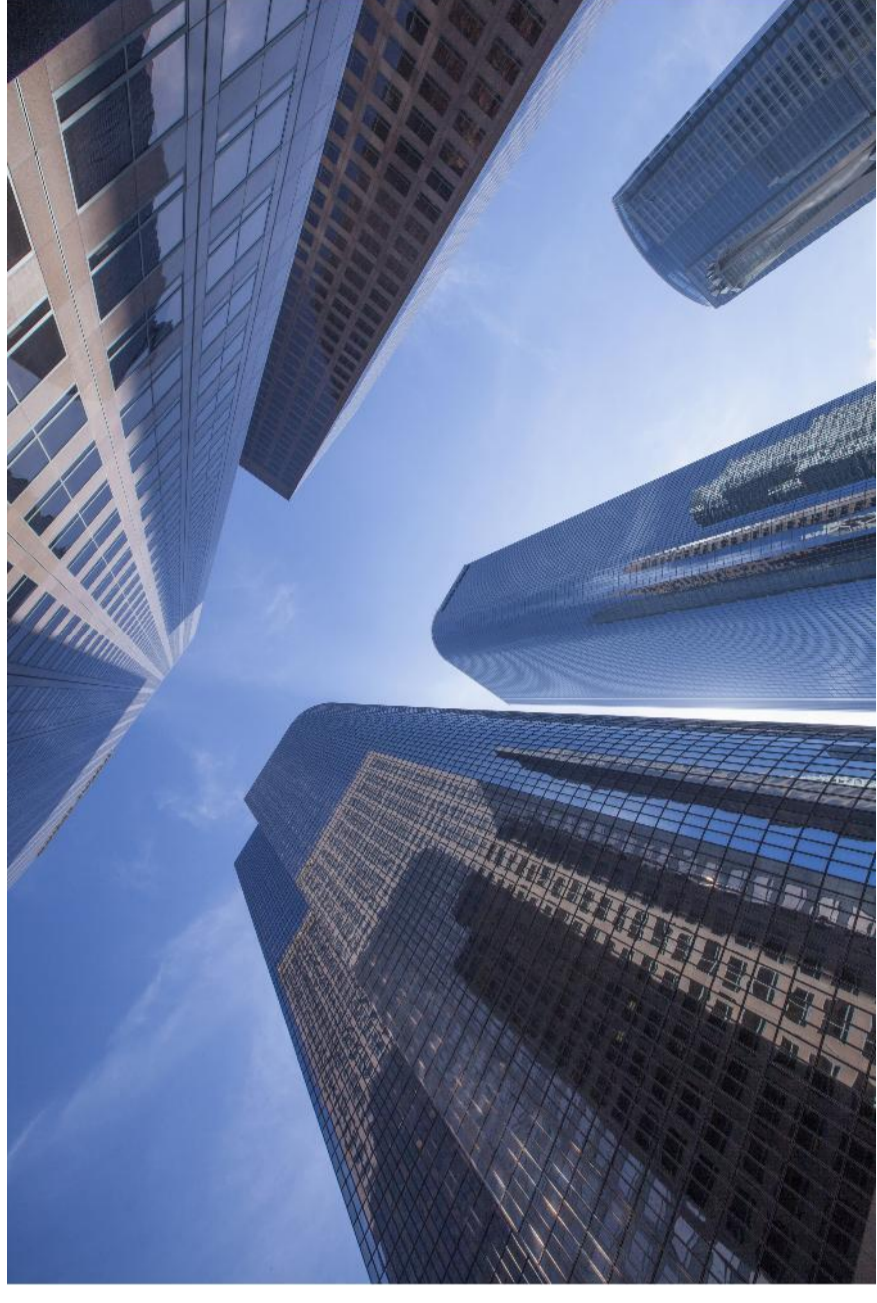

Fundamentals of Protection...

Inherited from the design and technology of the top-selling EasyPact range of MCCB worldwide, EasyPact EZS is an economical solution that is the best value for money in its class. It is specially designed and dedicated to small-medium sized buildings, factories, OEMs and many simple yet demanding applications.

EasyPact EZS is equipped with a classic Schneider Electric inbuilt TM-D thermal-magnetic trip unit, ranging from 16 to 630A. Accessories are common and compatible with the entire EasyPact range of MCCB.

The easy choice for affordable price

Easy to choose

- > From 16 to 630A
- > Up to 50kA at 415V
- > Up to 4 poles
- > Up to 3 frame sizes

Easy to install

- > Fixed front mounting
- > Front connections
- > Field-installable auxiliaries and accessories
- > Installation video through QR Code

Easy to use

- > Hassle-free on any setting requirements
- > Small size optimised for tight spaces
- > Positive contact indication for safety and reliability



Timely delivery, wherever you are

Schneider Electric offers a world-renowned logistics network capable of getting EasyPact™ EZS products to you fast, wherever you are.

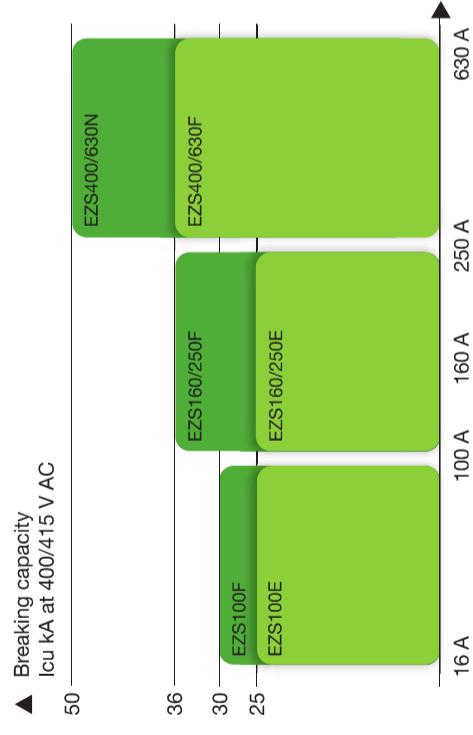

Functions and characteristics **A-1**

Installation recommendations **B-1**

Dimensions and connection **C-1**

Technical data supplement **D-1**

Catalogue numbers **E-1**

Functions and characteristics

Presentation

III

Introduction

A-2

General characteristics

A-2

Characteristics and performance

A-4

Protection of distribution systems

A-6

Accessories and auxiliaries

A-7

Overview

A-7

Device installation

A-8

Selection of auxiliaries

A-9

Indication contacts

A-10

Remote tripping

A-11

Rotary handles

A-12

Installation recommendations

B-1

Dimensions and connection

C-1

Technical data supplement

D-1

Catalogue numbers

E-1

| | | |
|--|---------|---------|
| EasyPact | | |
| EZS160F  | | |
| Ui | 690V | |
| Uimp | 8kV | |
| Ue(V~) | Icu(kA) | Ics(kA) |
| 220/240 | 70 | 70 |
| 380/400 | 36 | 36 |
| 415 | 36 | 36 |
| 440 | 36 | 18 |
| 50/60Hz | | |
| IEC/EN60947-2 | | |
| Cat. A | | |

Standardised characteristics indicated on the rating plate:

- Type of device, frame size and breaking capacity class
- Rated insulation voltage
- Rated impulse withstand voltage
- Operational voltage
- Ultimate breaking capacity for various values of the rated operational voltage U_e
- Service breaking capacity
- Suitable for isolation symbol
- Reference standard

Note: when the circuit breaker is equipped with an extended rotary handle, the door must be opened to access the rating plate.

Compliance with standards

EasyPact EZS circuit breakers and auxiliaries comply with the following international recommendations:

- IEC 60947-1: general rules.
- IEC 60947-2: circuit breakers.

Pollution degree

EasyPact EZS circuit breakers are certified for operation in pollution-degree III environments as defined by IEC standards 60947-1 and 60664-1 (industrial environments).

Climatic withstand

EasyPact EZS circuit breakers have successfully passed the tests defined by the following standards for extreme atmospheric conditions:

- IEC 60068-2-1: dry cold (-55°C).
- IEC 60068-2-2: dry heat (+85°C).
- IEC 60068-2-30: damp heat (95 % relative humidity at 55°C).
- IEC 60068-2-52 severity level 2: salt mist.

Environment

EasyPact EZS respects the European environment directive EC/2002/95 concerning the restriction of hazardous substances (RoHS). All EasyPact EZS production sites have set up an ISO 14001 certified environmental management system.

Ambient temperature

- EasyPact EZS circuit breakers can be used between -25°C and +70°C. For temperatures higher than 40°C (65°C for circuit breakers used to protect motor feeders), devices must be derated ([see page B-2](#)).
- Circuit breakers should be put into service under normal ambient, operating-temperature conditions. Exceptionally, the circuit breaker can be put into service when the ambient temperature is between -35°C and -25°C.
- The permissible storage-temperature range for EasyPact EZS circuit breakers in the original packing is -50°C and +85°C.

Suitable for isolation with positive contact indication

All EasyPact EZS circuit breakers are suitable for isolation as defined in IEC standard 60947-2:

- The isolation position corresponds to the O (OFF) position.
- The operating handle cannot indicate the OFF position unless the contacts are effectively open.
- Padlocks cannot be installed unless the contacts are open.
- Installation of a rotary handle does not alter the reliability of the position-indication system.
- The isolation function is certified by tests guaranteeing:
 - The mechanical reliability of the position-indication system.
 - The absence of leakage currents.
 - Over voltage withstand capacity between upstream and downstream connections.
- The tripped position does not ensure isolation with positive contact indication. Only the OFF position guarantees isolation.

Installation in class II switchboards

All EasyPact EZS circuit breakers are class II front face devices. They can be installed through the door of class II switchboards (as per IEC standards 61140 and 60664-1) without downgrading switchboard insulation. Installation requires no special operations, even when the circuit breaker is equipped with a rotary handle.

Degree of protection

The following indications are in accordance with standards IEC 60529 (IP degree of protection) and IEC 62262 (IK protection against external mechanical impacts).

Bare circuit breaker with Escutcheon:

- with toggle: IP40, IK07 front face.
- with extended rotary handle: IP 54, IK08.

Circuit breaker installed in a switchboard:

- with toggle: IP40, IK07 front face.
- with extended rotary handle: IP 54, IK08.

TM-D thermal-magnetic trip units can be used on EasyPact EZS100-630 circuit breakers with performance levels E/F/N.

TM-D thermal-magnetic trip units



Protection

TM-D trip units are used mainly in electrical distribution applications for protection of cables supplied by transformers.

Thermal protection (Ir)

Thermal protection operates according to:

- Ir non-adjustable.
- non-adjustable time delay.

Magnetic protection (Im)

Short-circuit protection with a fixed or adjustable pick-up Im that initiates instantaneous tripping if exceeded.

- fixed pick-up.

Protection versions

- 3-pole:
- 3P 3D: 3-pole frame (3P) with detection on all 3 poles (3D).
- 4-pole:
- 4P 3D: 4-pole frame (4P) with detection on 3 poles (3D).



Insulation accessories ▶ E-3, E-6, E-9

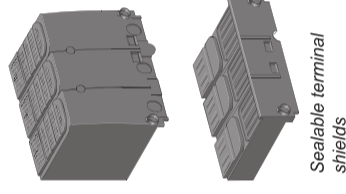

Connection ▶ B-3

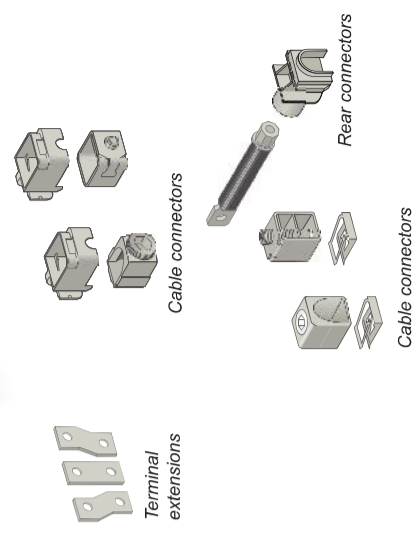

Electrical auxiliaries ▶ A-11

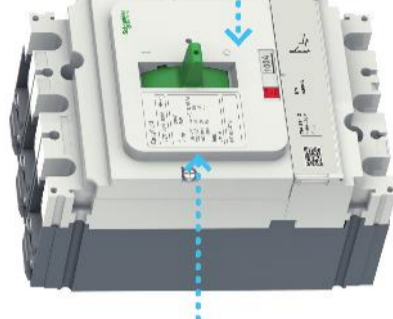
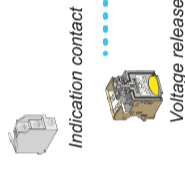

Control accessories ▶ A-12

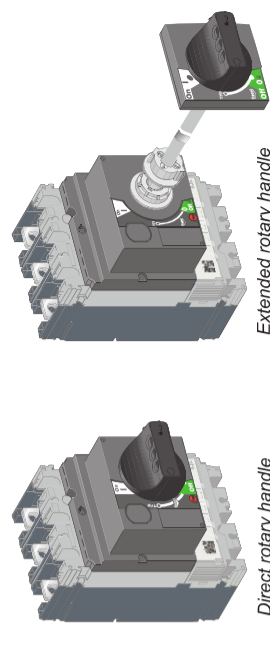

| Thermal-magnetic trip units | | TM16D to 250D | | | | | | | | | | TM320D to 600D | | | | | | | | | |
|-----------------------------|-----------------|---------------|-----|-----|-----|-----|-----|-----|-----|-----|-----|----------------|-----|-----|-----|-----|-----|-----|-----|-----|--|
| Ratings (A) | In at 40 °C (1) | 16 | 20 | 25 | 32 | 40 | 50 | 63 | 80 | 100 | 125 | 160 | 200 | 225 | 250 | 315 | 350 | 400 | 500 | 600 | |
| Circuit breaker | EZS100 | ■ | ■ | ■ | ■ | ■ | ■ | ■ | ■ | ■ | ■ | ■ | ■ | ■ | ■ | ■ | ■ | ■ | ■ | ■ | |
| | EZS160 | | | | | | | | | | | | | | | | | | | | |
| | EZS250 | | | | | | | | | | | | | | | | | | | | |
| | EZS400 | | | | | | | | | | | | | | | | | | | | |
| | EZS630 | | | | | | | | | | | | | | | | | | | | |
| Magnetic protection | | | | | | | | | | | | | | | | | | | | | |
| Pick-up (A) | Im | fixed | | | | | | | | | | | | | | | | | | | |
| accuracy ±20 % | EZS100 | 300 | 300 | 300 | 300 | 300 | 300 | 300 | 300 | 300 | 300 | 300 | 300 | 300 | 300 | 300 | 300 | 300 | 300 | 300 | |
| | EZS160 | | | | | | | | | | | | | | | | | | | | |
| | EZS250 | | | | | | | | | | | | | | | | | | | | |
| | EZS400 | | | | | | | | | | | | | | | | | | | | |
| | EZS630 | | | | | | | | | | | | | | | | | | | | |
| Thermal protection | | | | | | | | | | | | | | | | | | | | | |
| Pick-up (A) | Ir = In | fixed | | | | | | | | | | | | | | | | | | | |
| Neutral protection | | | | | | | | | | | | | | | | | | | | | |
| Unprotected neutral | 4P 3D | no detection | | | | | | | | | | | | | | | | | | | |

(1) For temperatures not equal to 40 °C, the thermal protection characteristics are modified. See the temperature derating table on page B-2.

EZS circuit breakers may be installed horizontally, vertically or flat on their back, without derating performance levels.

Fixed circuit breakers

Fixed circuit breakers are designed for standard connection using bars or cables with lugs. Bare-cable connectors are available for connection to bare copper or aluminium cables.

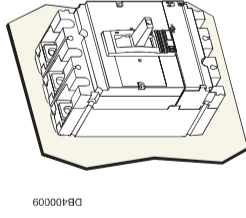

DB400090

Mounting on a backplate.

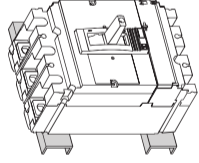

DB400010

Mounting on rails.

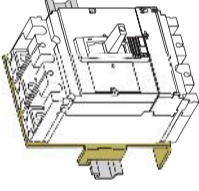

DB400011

Mounting on DIN rail (with adaptor).

EasyPact EZS160/250

Standard

All EasyPact EZS160~250 circuit breakers have slots for the electrical auxiliaries listed below.

- 3 **indication contacts** (see page A-10)
 - 2 ON/OFF (OF1 and OF2).
 - 1 trip indication (SD).
- 1 **remote-tripping release** (see page A-11)
 - either 1 MN undervoltage release.
 - or 1 MX shunt release.

All these auxiliaries can be installed with a rotary handle.

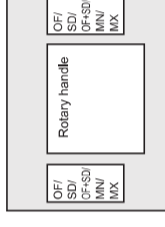

EasyPact EZS160

EasyPact EZS400/630

Standard

All EasyPact EZS400/630 circuit breakers have slots for the electrical auxiliaries listed below.

- 4 **indication contacts** (see page A-10)
 - 3 ON/OFF (OF3).
 - 1 trip indication (SD).
- 1 **remote-tripping release** (see page A-11)
 - either 1 MN undervoltage release.
 - or 1 MX shunt release.

All these auxiliaries can be installed with a rotary handle.

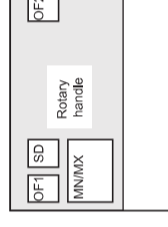

EasyPact EZS160-250

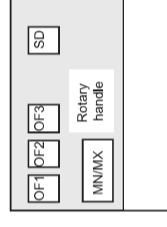

EasyPact EZS400-630

One contact model provides circuit-breaker status indications (OF - SD).



EasyPact EZS100 auxiliary switch



For EasyPact EZS100

These common-point changeover contacts provide remote circuit-breaker status information. They can be used for indications, electrical locking, relaying, etc. They comply with the IEC 60947-5 international recommendation.

EasyPact EZS100

Indication contacts

Provide remote circuit breaker status information. They can be used for indications, electrical locking, relaying, etc. Common-point changeover contacts.

Auxiliary switch (ON/OFF)

AX indicates the position of the circuit breaker contacts.

Alarm switch (trip indication)

- AL indicates that the circuit breaker has tripped due to:
 - an overload.
 - a short-circuit.
 - operation of a voltage release.

They return to de-energised state when the circuit breaker is reset.

Characteristics

| Contacts | | | |
|--------------------------------------|--|---------------|------|
| Rated thermal current (A) | 5 | 10 mA at 24 V | |
| Minimum load | | AC12 | AC15 |
| Utilisation category (IEC 60947-5-1) | 24 V | 5 | 5 |
| Operational current (A) | 48 V | 5 | 5 |
| | 125 V | 5 | 3 |
| | 250 V | 3 | 2 |
| Connections | | | |
| Connection wire length | 450 mm | | |
| Cross-section | EZS100: 1 mm ² , EZS250: 1.5 mm ² | | |

EasyPact EZS160-630

Functions

Breaker-status indications, during normal operation or after a fault

- A single type of contact provides all the different indication functions:
- OF (ON/OFF) indicates the position of the circuit breaker contacts.
 - SD (trip indication) indicates that the circuit breaker has tripped due to:
 - an overload.
 - a short-circuit.
 - operation of a voltage release.
 - operation of the "push to trip" button.
 - disconnection when the device is ON.
- The SD contact returns to de-energised state when the circuit breaker is reset.

Installation

- OF, SD functions: a single type of contact provides all these different indication functions, depending on where it is inserted in the device. The contacts clip into slots behind the front cover of the circuit breaker.

Electrical characteristics of auxiliary contacts

| Contacts | Standard | Low level OF, SD |
|----------------------------------|--------------------------|---------------------|
| Types of contacts | All | 5 |
| Rated thermal current (A) | 6 | 5 |
| Minimum load | 100 mA at 24 V DC | 1 mA at 4 V DC |
| Utilisation cat. (IEC 60947-5-1) | AC12 AC15 DC12 DC14 | AC12 AC15 DC12 DC14 |
| Operational current (A) | 24 V AC/DC 6 6 6 1 | 5 3 5 1 |
| | 48 V AC/DC 6 6 2.5 0.2 | 5 3 2.5 0.2 |
| | 110 V AC/DC 6 5 0.6 0.05 | 5 2.5 0.6 0.05 |
| | 220/240 V AC 6 4 | 5 2 |
| | 250 V DC - | 5 - |
| | 380/440 V AC 6 2 | 5 - 1.5 - |

MN undervoltage release

- This release trips the circuit breaker when the control voltage drops below a tripping threshold.
- The tripping threshold is between 0.35 and 0.7 times the rated voltage.
- Circuit breaker closing is possible only if the voltage exceeds 0.85 times the rated voltage.

Characteristics

| | | |
|-----------------------|-----------------------|---------------------------------------|
| Power supply | V AC | 50/60 Hz: 24 - 48 - 100/130 - 200/240 |
| | | 50 Hz: 380/415 60 Hz: 208/277 |
| | V DC | 12 - 24 - 30 - 48 - 60 - 125 - 250 |
| Operating threshold | Opening | 0.35 to 0.7 Un |
| | Closing | 0.85 Un |
| Operating range | | 0.85 to 1.1 Un |
| Consumption (VA or W) | Pick-up: 10 - Hold: 5 | |
| Response time (ms) | | 50 |

Time-delay unit for an MN release

A time delay unit for the MN release eliminates the risk of nuisance tripping due to a transient voltage dip lasting ≤ 200 ms. For shorter micro-outages, a system of capacitors provides temporary supply to the MN at $U > 0.7$ to ensure non tripping. The correspondence between MN releases and time-delay units is shown below.

Power supply

| Unit with fixed delay 200 ms | Corresponding MN release |
|------------------------------|--------------------------|
| 48 V AC | 48 V DC |
| 220 / 240 V AC | 250 V DC |

Unit with adjustable delay (0.5s, 0.9s, 1.5s, 3s)

| | |
|-------------------|----------|
| 48 - 60 V AC/DC | 48 V DC |
| 100 - 130 V AC/DC | 125 V DC |
| 220 - 250 V AC/DC | 250 V DC |

MX shunt release

The MX release opens the circuit breaker via an impulse-type (≥ 20 ms) or maintained order.

Opening conditions

When the MX release is supplied, it automatically opens the circuit breaker. Opening is ensured for a voltage $U \geq 0.7 \times U_n$.

Characteristics

| | | |
|-----------------------|-------------|---------------------------------------|
| Power supply | V AC | 50/60 Hz: 24 - 48 - 100/130 - 200/240 |
| | | 50 Hz: 380/415 60 Hz: 208/277 |
| | V DC | 12 - 24 - 30 - 48 - 60 - 125 - 250 |
| Operating range | | 0.7 to 1.1 Un |
| Consumption (VA or W) | Pick-up: 10 | |
| Response time (ms) | | 50 |

Circuit breaker control by MN or MX

When the circuit breaker has been tripped by an MN or MX release, it must be reset before it can be reclosed. MN or MX tripping takes priority over manual closing. In the presence of a standing trip order, closing of the contacts, even temporary, is not possible. Connection using wires up to 1.5mm² to integrated terminal blocks.

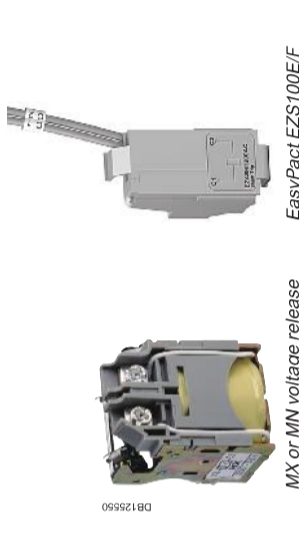

MX or MN voltage release

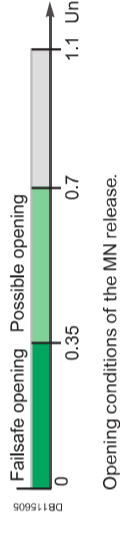

Opening conditions of the MN release.

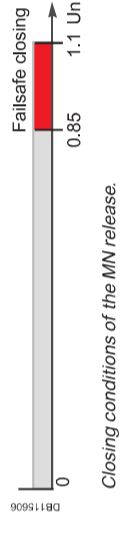

Closing conditions of the MN release.

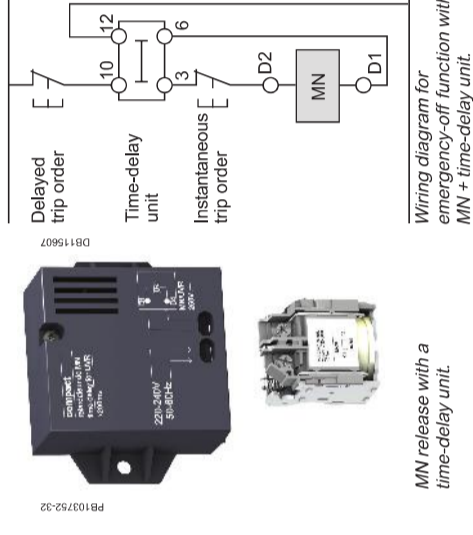

Wiring diagram for emergency-off function with MN + time-delay unit.

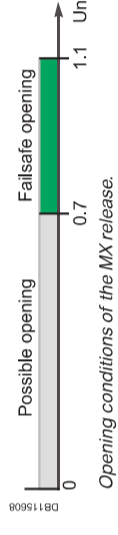

Opening conditions of the MX release.

Note: circuit breaker opening using an MN or MX release must be reserved for safety functions. This type of tripping increases wear on the opening mechanism. Repeated use reduces the mechanical endurance of the circuit breaker by 50%.

There are two types of rotary handle:

- direct rotary handle
- extended rotary handle.



EasyPact EZS with a rotary handle.



EasyPact EZS with an extended rotary handle installed at the back of a switchboard, with the keylock option and key.

Direct rotary handle

Standard handle

Degree of protection IP40, IK07.

The direct rotary handle maintains:

- visibility of and access to trip-unit settings.
- suitability for isolation.
- indication of the three positions O (OFF), I (ON) and tripped.
- access to the "push to trip" button.

Device locking

The rotary handle facilitates circuit-breaker locking.

- Padlocking:
 - standard situation, in the OFF position, using 1 to 3 padlocks, shackle diameter 5 to 8 mm, not supplied.

Extended rotary handle

Degree of protection IP54, IK08.

The extended rotary handle makes it possible to operate circuit breakers installed at the back of switchboards, from the switchboard front. It maintains:

- visibility of and access to trip-unit settings.
- suitability for isolation.
- indication of the three positions O (OFF), I (ON) and tripped.

Device and door padlocking

Padlocking locks the circuit-breaker handle and disables door opening:

- standard situation, in the OFF position, using 1 to 3 padlocks, shackle diameter 5 to 8 mm, not supplied.

Parts of the extended rotary handle

- A unit that replaces the front cover of the circuit breaker (secured by screws).
- An assembly (handle and front plate) on the door that is always secured in the same position, whether the circuit breaker is installed vertically or horizontally.
- An extension shaft that must be adjusted to the distance. The min/max distance between the back of circuit breaker and door is:
 - 145...530 mm for EasyPact EZS100.
 - 185...600 mm for EasyPact EZS160/250.
 - 209...600 mm for EasyPact EZS 400/630.

Installation recommendations

| | |
|--------------------------------------|------------|
| <i>Presentation</i> | III |
| <i>Functions and characteristics</i> | A-1 |
| Temperature derating | B-2 |
| Installation in switchboards | B-3 |
| Power supply and Safety clearances | B-3 |
| Installation example | B-4 |
| <i>Dimensions and connection</i> | C-1 |
| <i>Technical data supplement</i> | D-1 |
| <i>Catalogue numbers</i> | E-1 |

Ambient temperature

- EasyPact EZS devices are equipped with fixed thermal-magnetic trip units.
- EasyPact EZS circuit breakers may be used between -25°C and +70°C.
 - EasyPact EZS circuit breakers should be put into service under normal ambient operating temperature conditions. Exceptionally, the circuit breaker may be put into service when the ambient temperature is between -35°C and -25°C.
 - the permissible storage-temperature range for EasyPact EZS circuit breakers in the original packing is -35°C to +85°C.

To determine tripping times using time/current curves, use I_r values corresponding to the thermal setting on the device, corrected as indicated in the tables below.

EZS100

| Rated current (A) | Temperature 40°C | Temperature 45°C | Temperature 50°C | Temperature 55°C | Temperature 60°C | Temperature 65°C | Temperature 70°C |
|-------------------|------------------|------------------|------------------|------------------|------------------|------------------|------------------|
| 16 | 16.7 | 16.3 | 16 | 15.7 | 15.6 | 15.1 | 14.7 |
| 20 | 20.4 | 20.2 | 20 | 19.7 | 19.2 | 18.9 | 18.5 |
| 25 | 25.7 | 25.3 | 25 | 24.7 | 24.5 | 24.3 | 24.0 |
| 32 | 33.5 | 32.7 | 32 | 31.4 | 31.0 | 30.4 | 29.9 |
| 40 | 40.9 | 40.4 | 40 | 39.5 | 38.0 | 37.6 | 37.1 |
| 50 | 52.1 | 51.0 | 50 | 49.3 | 48.1 | 47.3 | 46.6 |
| 63 | 64.9 | 63.9 | 63 | 62.0 | 60.4 | 59.4 | 58.5 |
| 80 | 82.2 | 81.1 | 80 | 78.6 | 77.3 | 76.7 | 76.1 |
| 100 | 103.0 | 101.0 | 100 | 99.0 | 94.0 | 94.0 | 93.0 |

EZS160~630

| Rated current (A) | Temperature 40°C | Temperature 45°C | Temperature 50°C | Temperature 55°C | Temperature 60°C | Temperature 65°C | Temperature 70°C |
|-------------------|------------------|------------------|------------------|------------------|------------------|------------------|------------------|
| 100 | 100 | 97.0 | 95.0 | 92.0 | 89.0 | 86.0 | 83.0 |
| 125 | 125 | 122.0 | 119.0 | 116.0 | 113.0 | 109.0 | 106.0 |
| 140 | 140 | 135.5 | 130.9 | 126.1 | 121.2 | 116.0 | 110.6 |
| 160 | 160 | 156.0 | 152.0 | 148.0 | 144.0 | 140.0 | 136.0 |
| 180 | 180 | 173.2 | 166.2 | 158.8 | 151.0 | 142.9 | 134.2 |
| 200 | 200 | 195.0 | 190.0 | 185.0 | 180.0 | 175.0 | 170.0 |
| 225 | 225 | 216.9 | 208.6 | 199.9 | 190.7 | 181.2 | 171.1 |
| 250 | 250 | 244.0 | 238.0 | 231.0 | 225.0 | 219.0 | 213.0 |
| 315 | 315 | 307.6 | 300.0 | 292.1 | 284.1 | 275.9 | 267.3 |
| 350 | 350 | 339.5 | 328.8 | 317.6 | 306.1 | 294.1 | 281.5 |
| 400 | 400 | 390.0 | 379.3 | 368.5 | 357.3 | 345.8 | 334.0 |
| 500 | 500 | 489.6 | 479.0 | 468.0 | 457.0 | 445.4 | 433.6 |
| 600 | 600 | 587.0 | 574.0 | 560.6 | 547.0 | 532.7 | 518.0 |

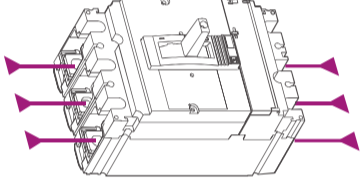

Power supply from the top or bottom

EZS circuit breakers can be supplied from either the top or the bottom without any reduction in performance. This capability facilitates connection when installed in a switchboard. All connection and insulation accessories can be used on circuit breakers supplied either from the top or bottom.

General rules

When installing a circuit breaker, minimum distances (safety clearances) must be maintained between the device and panels, bars and other protection devices installed nearby. These distances, which depend on the ultimate breaking capacity, are defined by tests carried out in accordance with standard IEC 60947-2.

If installation conformity is not checked by type tests, it is also necessary to:

- use insulated bars for circuit-breaker connections
 - segregate the busbars using insulating screens.
- For EZS100 to 630 devices, terminal shields and interphase barriers are recommended and may be mandatory depending on the operating voltage of the device and type of installation (fixed, withdrawable, etc.).

Power connections

The table below indicates the rules to be respected for EZS100 to 630 devices to ensure the insulation of live parts for fixed devices.

EZS100 to 630: rules to be respected to ensure the insulation of live parts

| Type of connection | Fixed, front connection | Fixed, rear connection |
|---|--|--------------------------------------|
| Possible, recommended or mandatory accessories: | No insulating accessory | Interphase barriers (DB115029) |
| | Insulated bars | Long terminal shields (1) (DB115060) |
| With: | Insulated bars | Short terminal shields (DB115061) |
| | Extension terminals Cables + crimp lugs | Interphase barriers (DB115029) |
| operating voltage ≤ 440 V | Insulated bars | Interphase barriers (DB115029) |
| | Bare cables + connectors | Interphase barriers (DB115029) |
| type of conductor | Insulated bars | Interphase barriers (DB115029) |
| | Bare cables + connectors | Interphase barriers (DB115029) |
| | Possible | Possible |
| | No | Mandatory (supplied) |
| | Possible for EZS100 to 250 | Possible for EZS100 to 250 |
| | No | Mandatory (supplied) |
| | Possible | Possible |
| | Possible (instead of ph. barriers) | Recommended |
| | Possible for EZS100 to 250 | Recommended |
| | Possible (instead of ph. barriers) | Recommended |

(1) Long terminal shields provide a degree of protection of IP40 (ingress) and IK07 (mechanical impact).

Safety clearance

Minimum distance between two adjacent circuit breakers

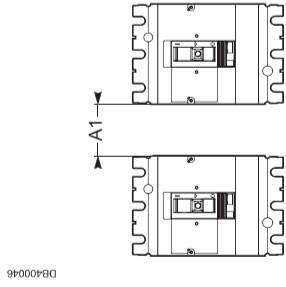

Minimum distance between circuit breaker and front or rear panels

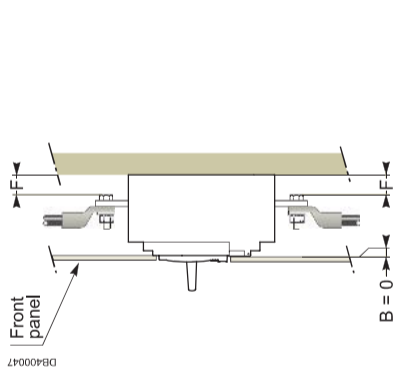

Bare or painted sheet metal

Note: if $F < 8$ mm: an insulating screen or long terminal shield is mandatory.

Minimum distance between circuit breaker and top, bottom or side panels

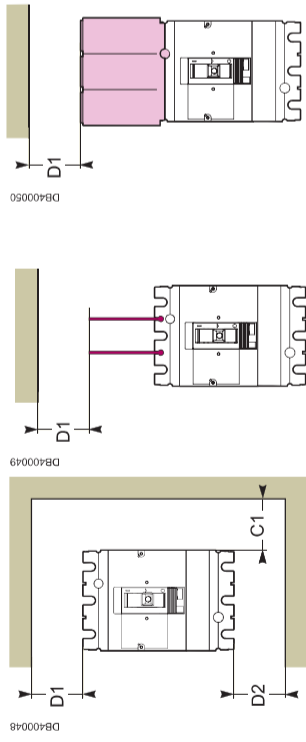

Devices without accessories.

Devices with interphase barriers or long terminal shields.

Minimum safety clearances for EZS100 to 630

| Dimensions (mm) circuit breaker | Insulation, insulated bars or painted sheet metal | | Bare sheet metal | | | | |
|------------------------------------|---|----|------------------|----|----|----|----|
| | C1 | D1 | D2 | C1 | D1 | D2 | A1 |
| EZS100-250 $U \leq 440V$ | 0 | 30 | 30 | 5 | 35 | 35 | 0 |
| EZS400-630 $U \leq 440V$ | 0 | 30 | 30 | 5 | 60 | 60 | 0 |

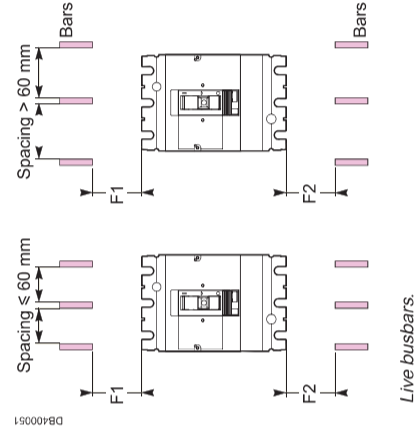

Clearances with respect to live bare busbars

Minimum clearances for EZS100 to 630

| Operating voltage | Clearances with respect to live bare busbars spacing ≤ 60 mm | | | Clearances with respect to live bare busbars spacing > 60 mm | | |
|-------------------|---|-----|-----|--|-----|-----|
| | F1 | F2 | F2 | F1 | F2 | F2 |
| $U < 440 V$ | 350 | 350 | 80 | 350 | 80 | 80 |
| $U = 440 V$ | 350 | 350 | 120 | 350 | 120 | 120 |

These clearances can be reduced for special installations as long as the configuration is checked by tests.

Dimension and connection

| | |
|---|-------------|
| <i>Presentation</i> | <i>III</i> |
| <i>Functions and characteristics</i> | <i>A-1</i> |
| <i>Installation recommendations</i> | <i>B-1</i> |
| Dimensions and mounting | C-2 |
| EasyPact EZS100 | C-2 |
| Rotary handle for EasyPact EZS100 | C-5 |
| EasyPact EZS160 - 630 | C-6 |
| Direct rotary handle for EasyPact EZS160 - 630 | C-7 |
| Extended rotary handle for EasyPact EZS160 - 630 | C-8 |
| Front-panel cutouts | C-9 |
| EasyPact EZS160-630 | C-9 |
| Power connections | C-10 |
| EasyPact EZS100 | C-10 |
| EasyPact EZS160-630 | C-11 |
| Connection of insulated bars or cables with lugs to EasyPact EZS160 - 630 | C-13 |
| <i>Technical data supplement</i> | <i>D-1</i> |
| <i>Catalogue numbers</i> | <i>E-1</i> |

Dimensions

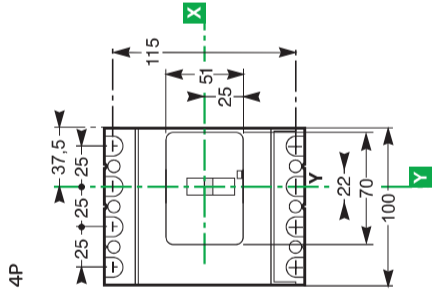
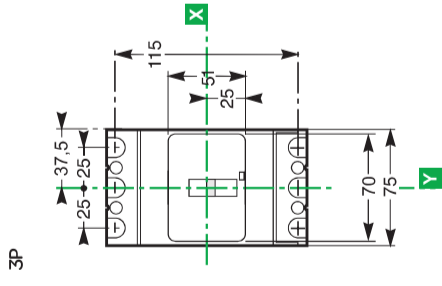
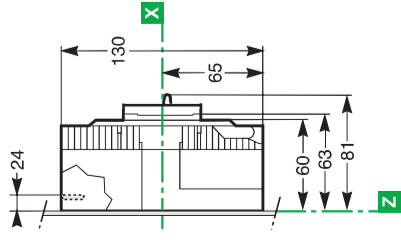

Backplate mounting

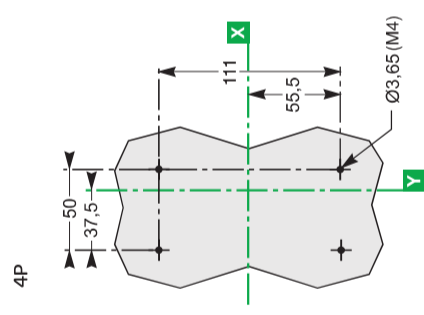
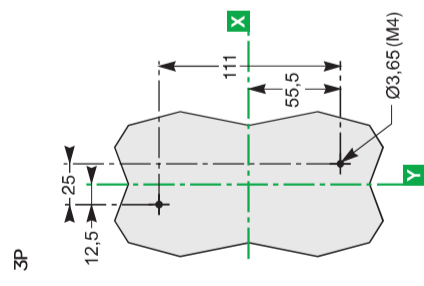

DIN rail mounting

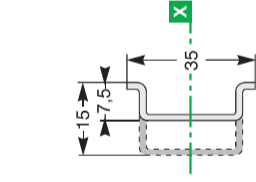
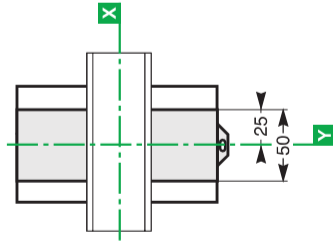
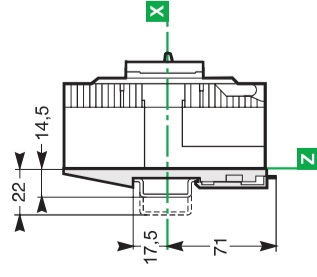

Front panel cutout

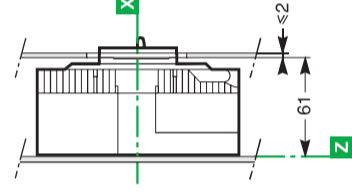

3P / 4P

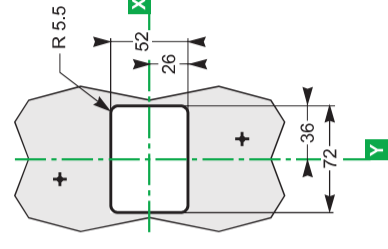

Terminal shield

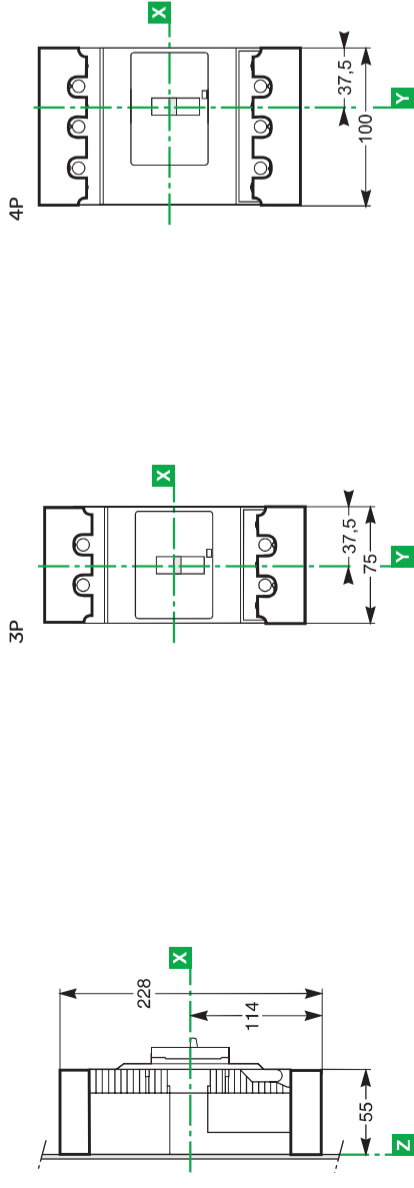

Interphase barrier

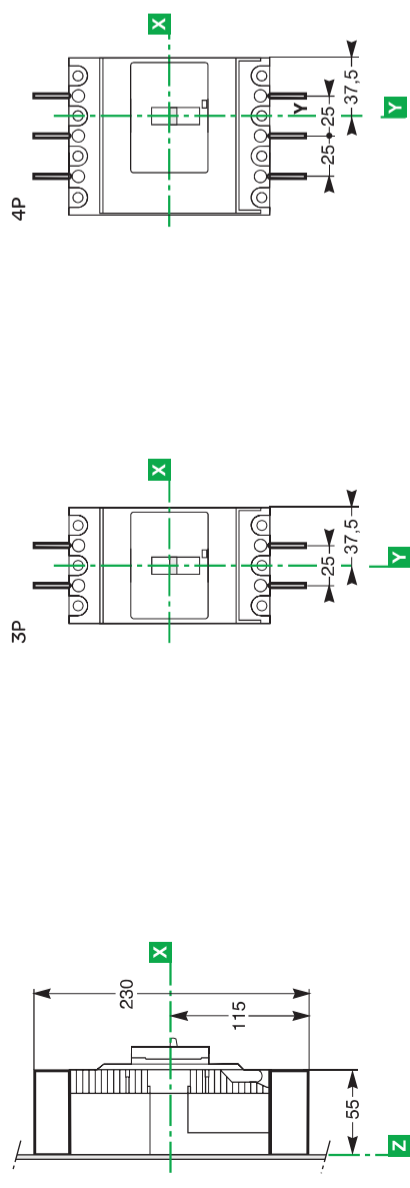

Direct rotary handle

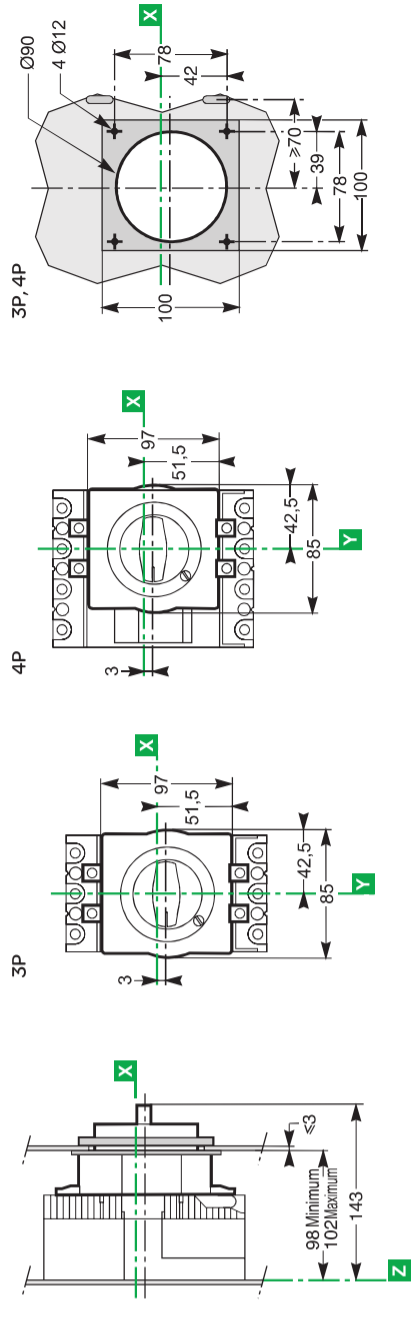

Extended rotary handle

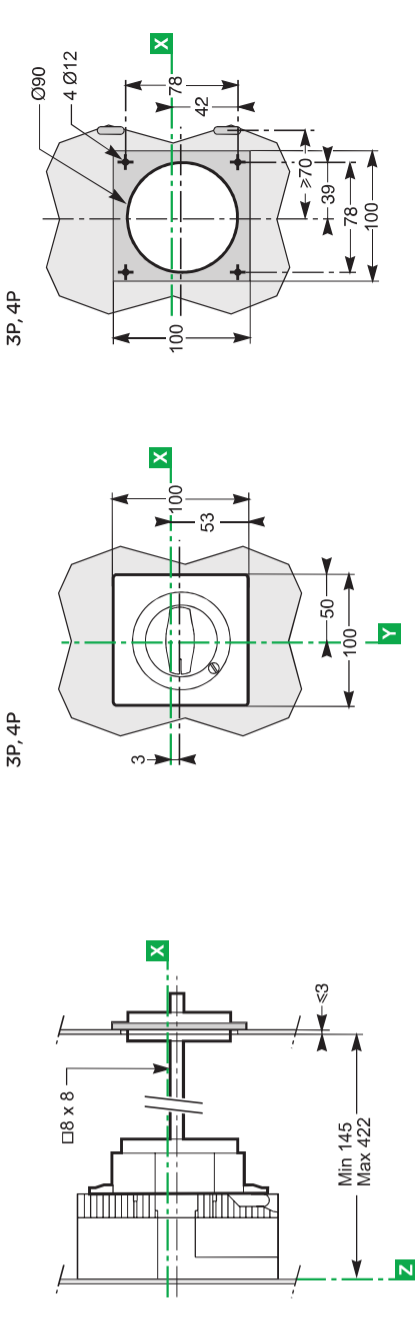

Dimensions

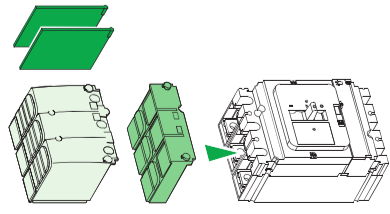

3P

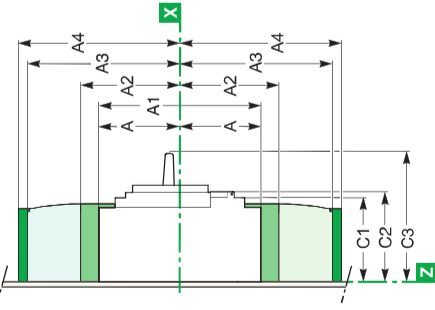

4P

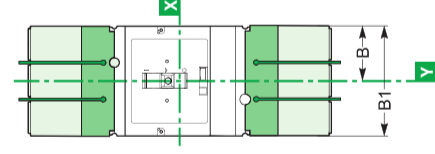

▲ Interphase barriers.
■ Short terminal shields.

■ Long terminal shields (also available for EZS400/630 spreaders with 52.5mm pitch):
B1=157.5mm, B2=210mm.

Mounting
On backplate

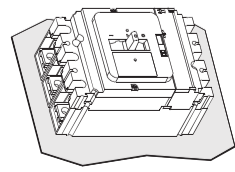

3P

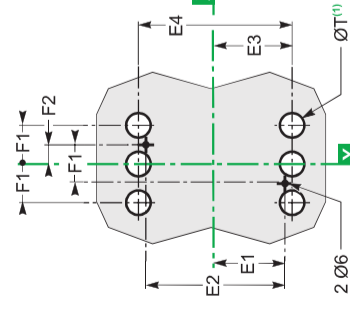

EZS 400/630

3P

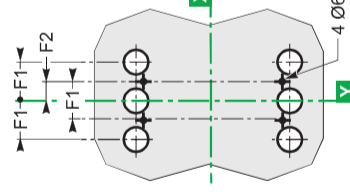

EZS160-630

4P

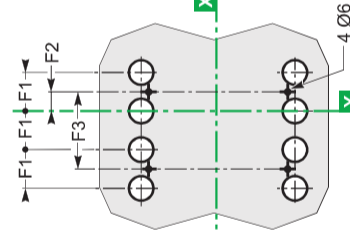

(1) The ØT holes are required for rear connection only.

On rails

3P

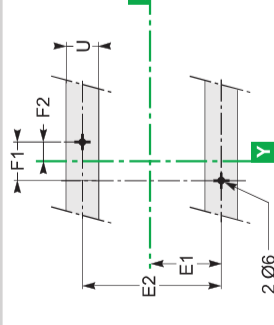

3P

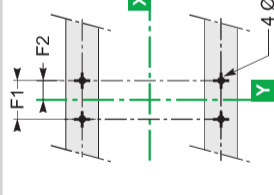

4P

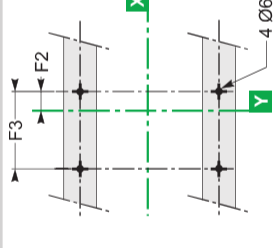

On DIN rail with adaptor plate (EZS160/250)

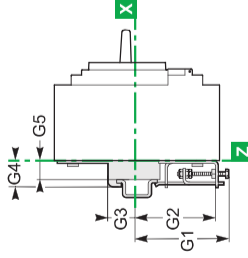

Type

| | | | | | | | | | | | | | |
|------------|-------|-------|-------|-----|-------|------|-----|-----|------|-----|--------------------|------|------|
| EZS160/250 | 80.5 | 161 | 94 | 145 | 178.5 | 52.5 | 105 | 140 | 81 | 86 | 111 ⁽¹⁾ | 62.5 | |
| EZS400/630 | 127.5 | 255 | 142.5 | 200 | 237 | 70 | 140 | 185 | 95.5 | 110 | 168 | 100 | |
| Type | E2 | E3 | E4 | F1 | F2 | F3 | G1 | G2 | G3 | G4 | G5 | ØT | U |
| EZS160/250 | 125 | 70 | 140 | 35 | 17.5 | 70 | 95 | 75 | 13.5 | 23 | 17.5 | 24 | ≤ 32 |
| EZS400/630 | 200 | 113.5 | 227 | 45 | 22.5 | 90 | - | - | - | - | - | 32 | ≤ 35 |

(1) C3=126mm, for EasyPact EZS225-250 installed with an extended rotary handle.

Dimensions

Fixed circuit breaker

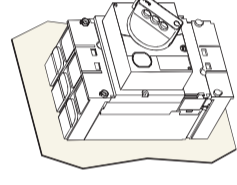

3P

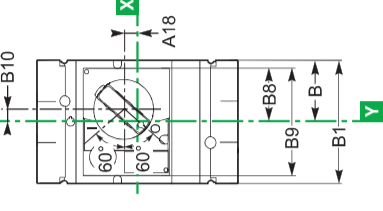

4P

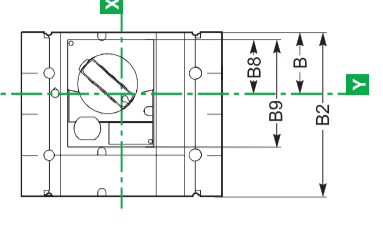

C8: without key/lock
C9: with key/lock

Type

| | | | | | | | | | |
|------------|------|-----|------|------|-----|------|-----|-----|-----|
| EZS160/250 | A14 | A15 | A18 | B8 | B9 | B10 | C7 | C8 | C9 |
| EZS400/630 | 27.5 | 73 | 9 | 45.5 | 91 | 9.25 | 121 | 155 | 164 |
| | 40 | 123 | 24.6 | 61.5 | 123 | 5 | 145 | 179 | 188 |

Dimensions

Fixed circuit breakers

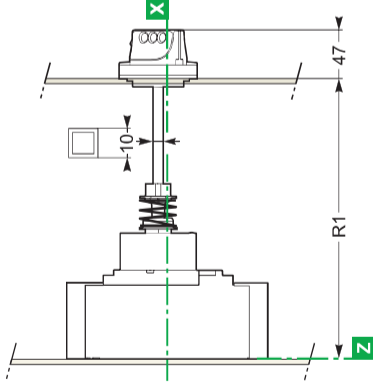
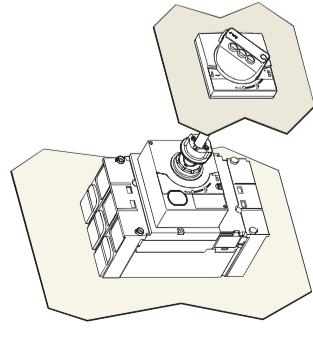

Cutout for shaft (mm)

| Type | R1 |
|------------|----------------------|
| EZS160/250 | min. 171 max. 600 |
| EZS400/630 | min. 195 max. 600 |

Dimensions and front-panel cutout

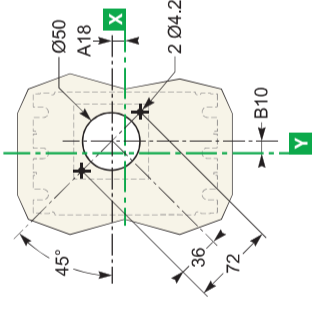
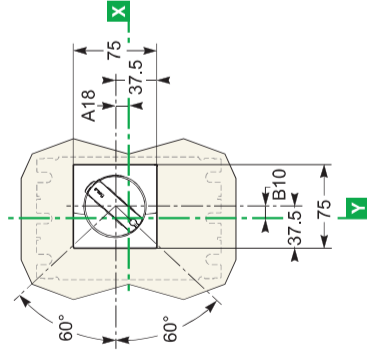

| Type | A18 | B10 |
|------------|------|------|
| EZS160/250 | 9 | 9.25 |
| EZS400/630 | 24.6 | 5 |

Bare sheet metal

For toggle with access to trip unit

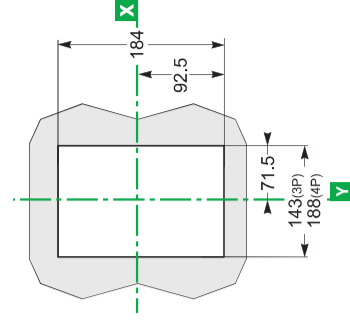
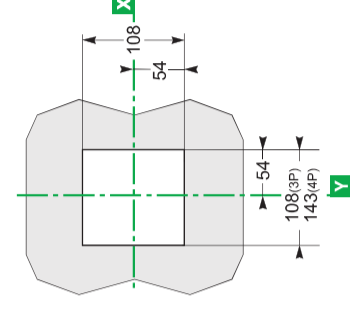
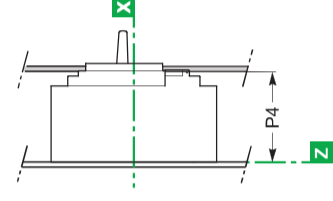
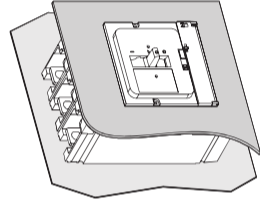

| Type | P4 |
|------------|-----|
| EZS160/250 | 83 |
| EZS400/630 | 107 |

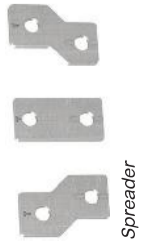

Spreader

Spreader

Increase the pitch of the circuit breaker terminals:

- EZS100 from 25 mm to 35 mm.

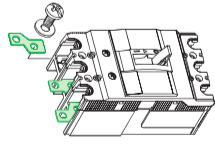

Designation

| Designation | Cat. no. |
|--|-----------|
| Spreader for 3-pole breaker (set of 3) | EZAS100 |
| Spreader for 4-pole breaker (set of 4) | EZAS100R4 |

Phase barriers

- Safety accessories for maximum insulation at the power connection points.
- Usable with all other connection accessories, except terminal shields.
- Each breaker is delivered with a set of phase barriers (2 for 3 poles and 3 for 4 poles breaker).
- Additional set of phase barriers available for insulation between outgoings or between 2 side by side-mounted breakers.

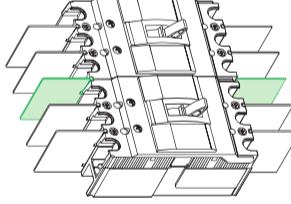
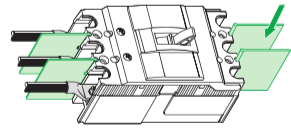

Phase barriers for EZS100



Connection locations

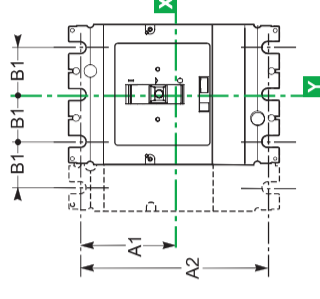

| Type | A1 | A2 | B1 | C1 | C2 |
|------------|-------|-----|----|------|------|
| EZS160 | 70 | 140 | 35 | 19.5 | 19.5 |
| EZS250 | 70 | 140 | 35 | 21.5 | 19.5 |
| EZS400-630 | 113.5 | 227 | 45 | 26 | 26 |

Front connections without accessories

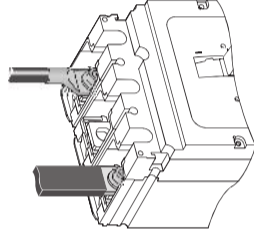

EZS160/250

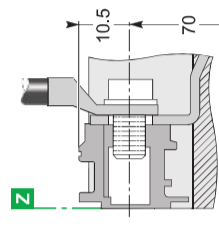

Cables with lugs/bars

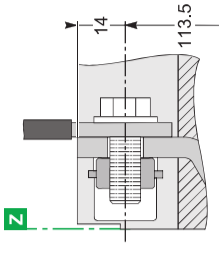

Bars/cables with lugs

EZS400/630

Connection with accessories

Long and short rear connectors

EZS160/250

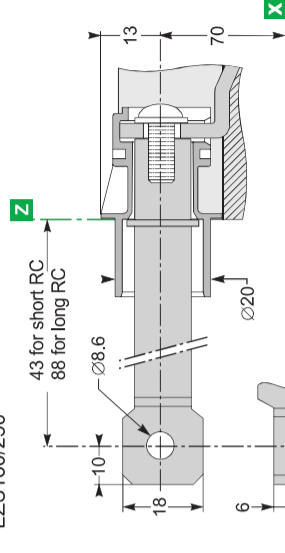

EZS400/630

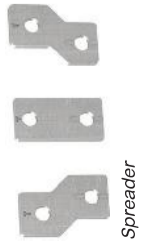
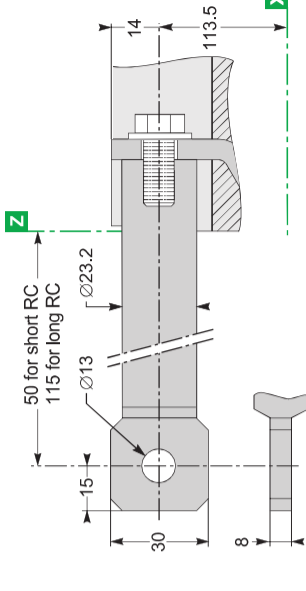

Terminal shield for EZS100

Terminal shields

Insulating accessory used for protection against direct contacts with power circuit connections. It provides a degree of protection of IP20 and mechanical resistance of IK07.

- The long terminal shield is used with front cable or isolated busbar connections.
- Designed for 3-pole EZS100.

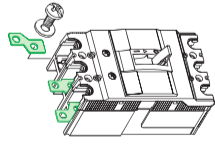

Designation

| Designation | Cat. no. |
|--|-----------|
| Terminal shield 3P; 60 mm depth (set of 2) | EZATSHD3P |
| Terminal shield 4P; 60 mm depth (set of 2) | EZATSHD4P |

Terminal shields

- Insulating accessory used for protection against direct contacts with power circuit connections. It provides a degree of protection of IP20 and mechanical resistance of IK07.
- The long terminal shield is used with front cable or isolated busbar connections.
- Designed for 3-pole EZS100.

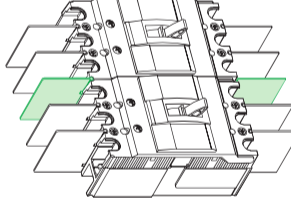
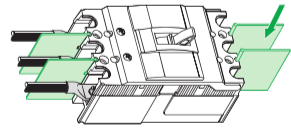

Terminal shield for EZS100



Dimensions and connection

Power connections

EasyPact EZS160 - 630

Dimensions and connection

Power connections

Connection of insulated bars or cables with lugs to EasyPact EZS160 - 630

Connection with accessories (cont.)

Spreaders 3P 4P

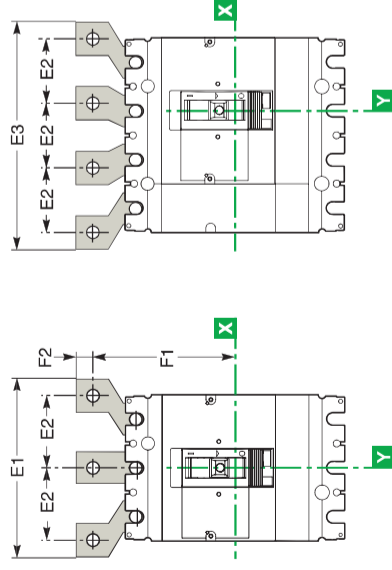
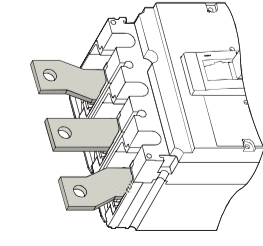

EZS160/250

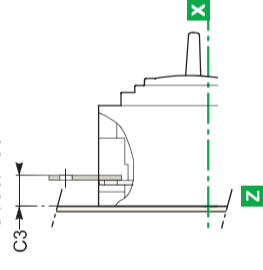

EZS400/630

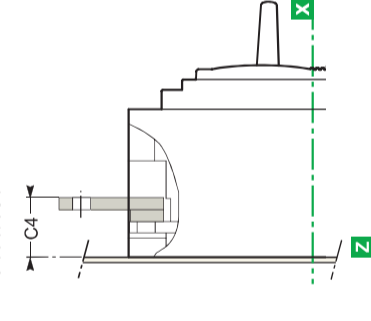

| Type | C3 | C4 | E1 | E2 | E3 | F1 | F2 |
|------------|------|----|------------|------------|--------------|--------------|----------|
| EZS160 | 23.5 | - | 114 | 45 | 159 | 100 | 11 |
| EZS250 | 25.5 | - | 114 | 45 | 159 | 100 | 11 |
| EZS400/630 | - | 44 | 135 170 | 52.5 70 | 187.5 240 | 152.5 166 | 15 15 |

Accessories for EZS160/250

Spreaders:
separate parts

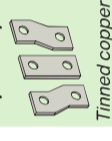

Tinned copper

Accessories for EZS400/630

Spreaders made up of separate parts for 52.5 and 70 mm pitch

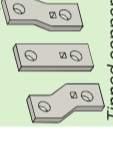

Tinned copper

Direct connection to EZS160 - 630

| Dimensions | EZS160/250 | EZS400/630 | |
|----------------------------|------------|------------|------------|
| Bars | L (mm) | ≤ 25 | ≤ 32 |
| | l (mm) | d + 10 | d + 15 |
| | d (mm) | ≤ 10 | ≤ 15 |
| | e (mm) | ≤ 6 | 3 ≤ e ≤ 10 |
| Lugs | Ø (mm) | 8.5 | 10.5 |
| | L (mm) | ≤ 25 | ≤ 32 |
| | Ø (mm) | 8.5 | 10.5 |
| Torque (Nm) ⁽¹⁾ | 15 | 50 | |
| Torque (Nm) ⁽²⁾ | 5/5 | 20/11 | |

⁽¹⁾ Tightening torque on the circuit breaker for lugs or bars.

⁽²⁾ Tightening torque on fixed devices for rear connectors.

Connection with accessories to EZS160/250 (IEC 228)

| Pole pitch | 35 mm |
|-------------------|---------------------------------------|
| Without spreaders | 45 mm |
| With spreaders | With spreaders or terminal extensions |
| Dimensions | EZS160 - 250 |

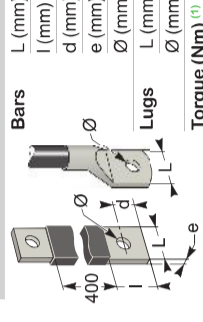

⁽¹⁾ Tightening torque on the circuit breaker for spreaders or terminal extensions.

Spreaders are supplied with flexible interphase barriers.

Connection with accessories to EZS400/630 (IEC 228)

| Pole pitch | 45 mm |
|-------------------|----------------|
| Without spreaders | 52.5 or 70 mm |
| With spreaders | With spreaders |
| Dimensions | EZS400/630 |

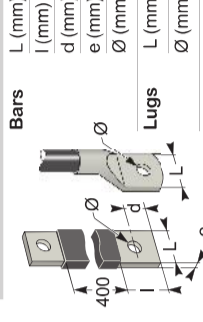

⁽¹⁾ Tightening torque on the circuit breaker for spreaders or terminal extensions.

Spreaders and right-angle, 45° and edgewise terminal extensions are supplied with flexible interphase barriers.

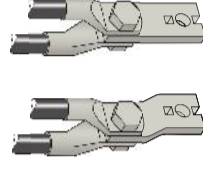

Mounting detail: 2 cables with lugs.

Technical data supplement

| | |
|---|------------|
| <i>Presentation</i> | <i>III</i> |
| <i>Functions and characteristics</i> | <i>A-1</i> |
| <i>Installation recommendations</i> | <i>B-1</i> |
| <i>Dimensions and connection</i> | <i>C-1</i> |
| Tripping Curve | D-2 |
| <i>Protection of distribution systems</i> | <i>D-2</i> |
| <i>Catalogue numbers</i> | <i>E-1</i> |

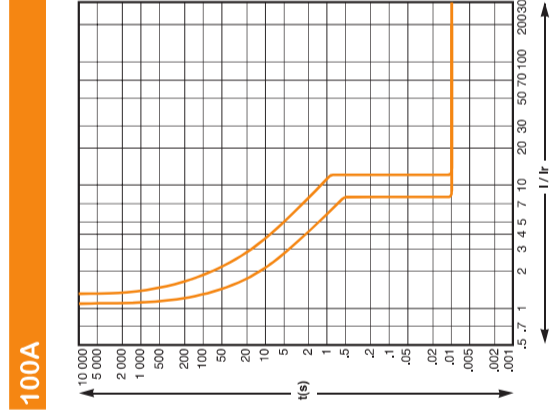
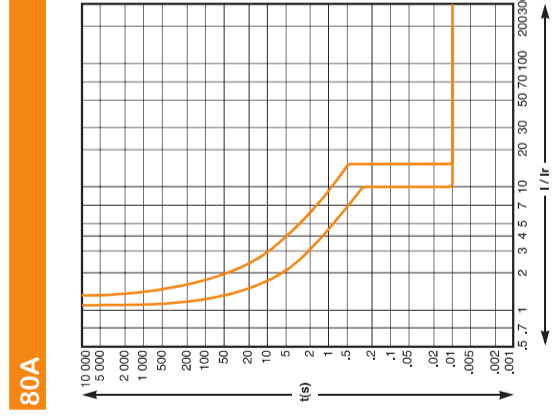
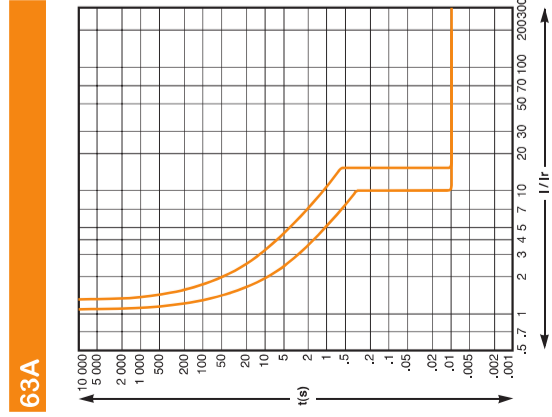
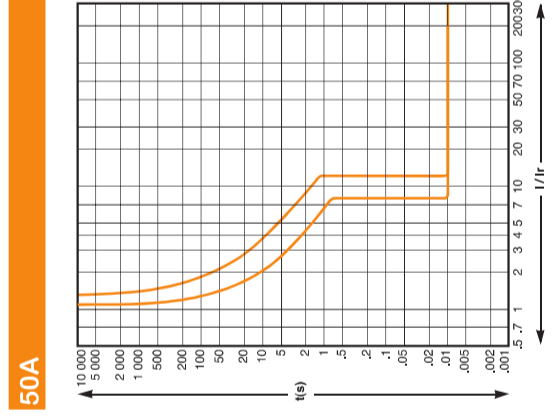
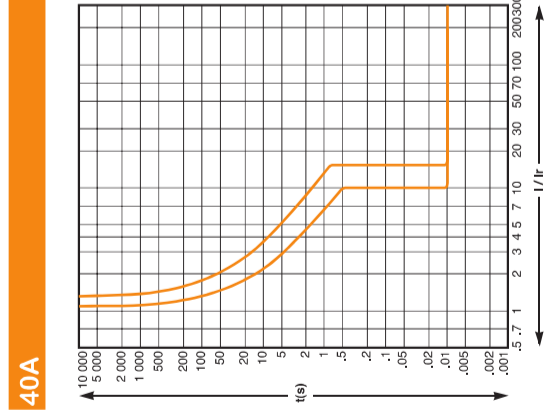
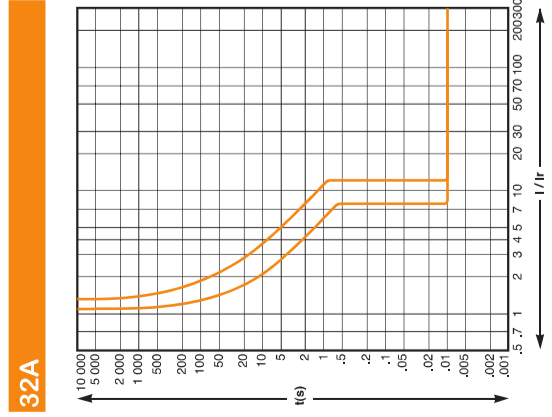
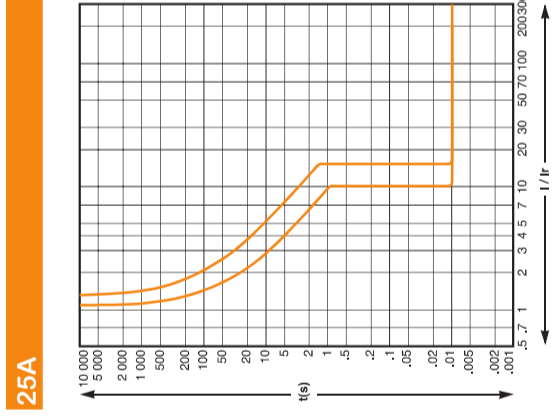
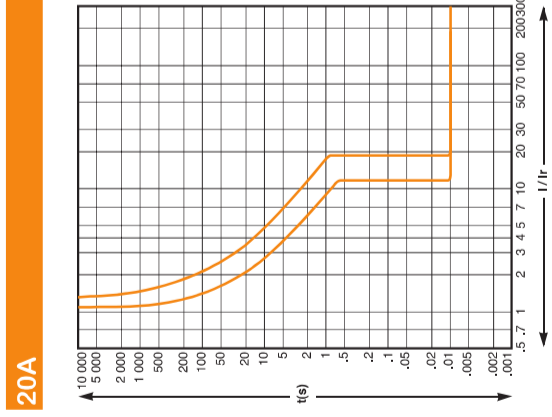
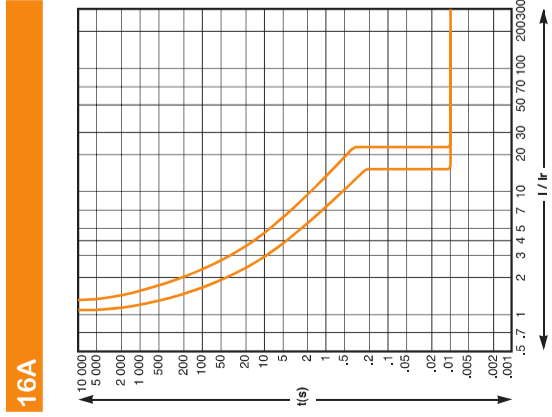

TM magnetic trip units

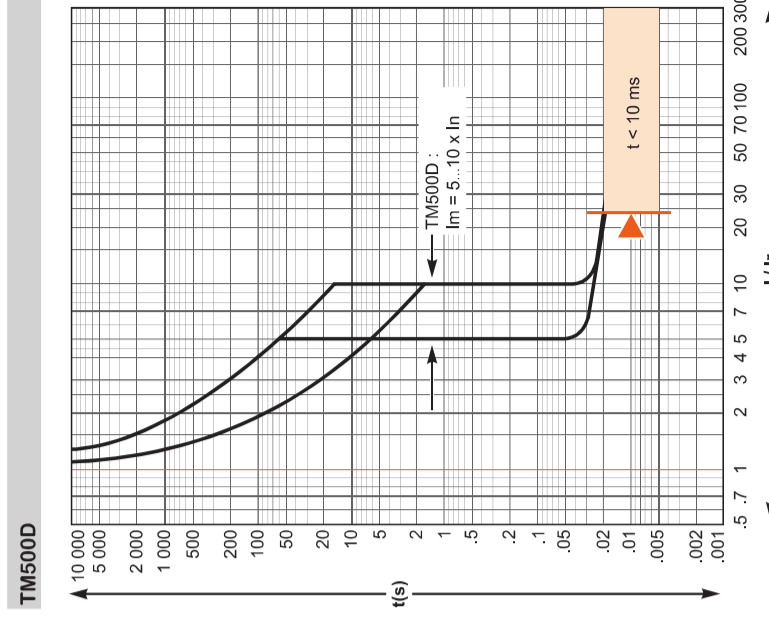
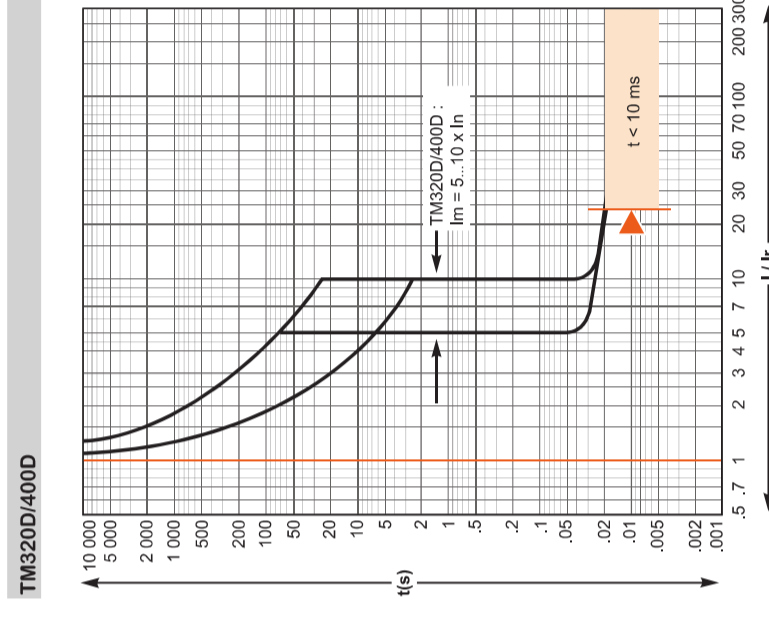
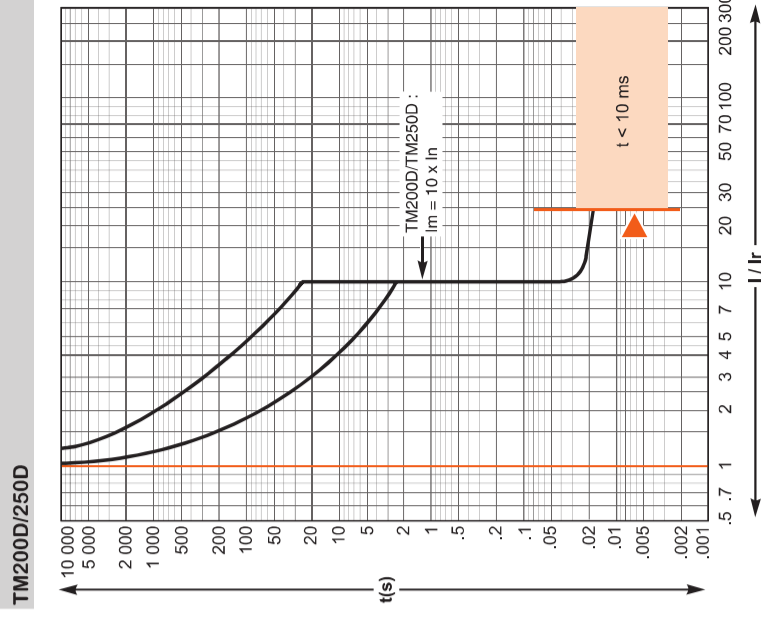
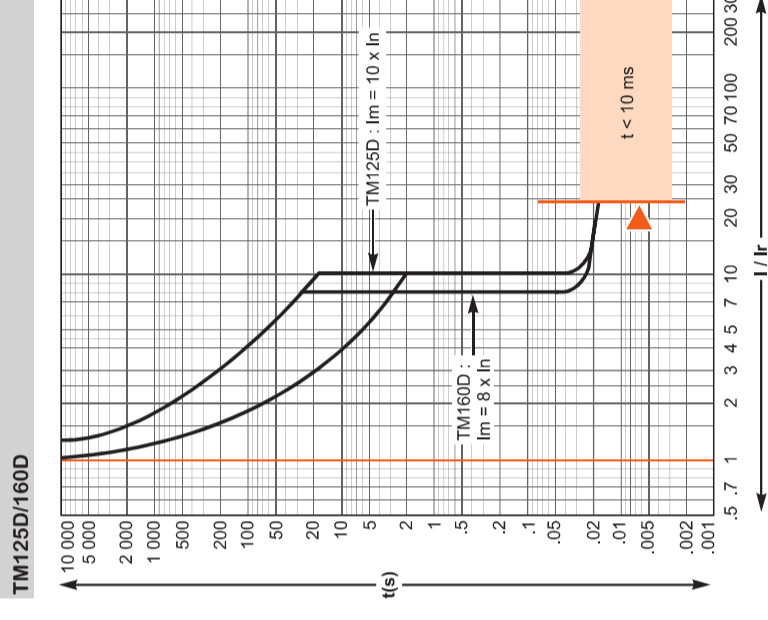

Reflex tripping.

TM magnetic trip units

TM600D

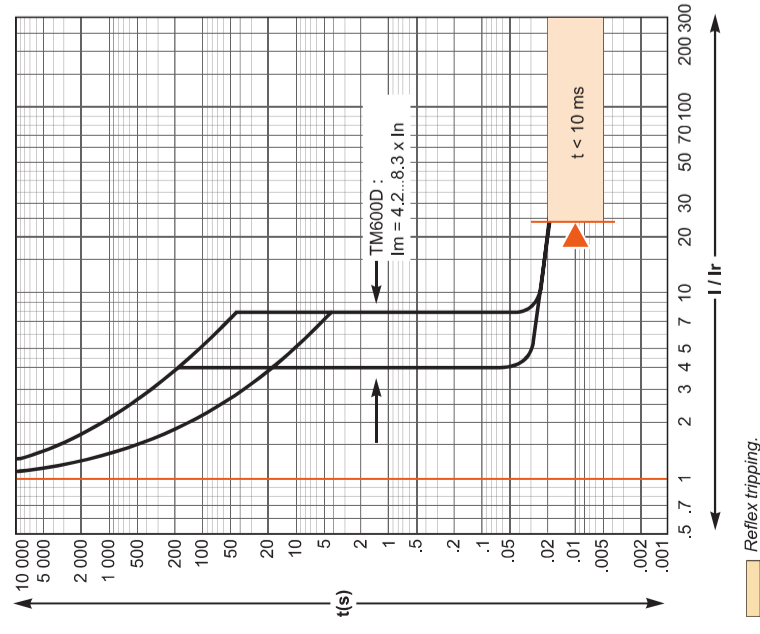

Catalogue numbers

| | |
|--------------------------------------|------------|
| <i>Presentation</i> | <i>III</i> |
| <i>Functions and characteristics</i> | <i>A-1</i> |
| <i>Installation recommendations</i> | <i>B-1</i> |
| <i>Dimensions and connection</i> | <i>C-1</i> |
| <i>Technical data supplement</i> | <i>D-1</i> |
| EZS100E/F | E-2 |
| Circuit breaker | E-2 |
| Accessories | E-3 |
| EZS160/250E/F | E-5 |
| Circuit breaker | E-5 |
| Accessories | E-6 |
| EZS400/630F/N | E-8 |
| Circuit breaker | E-8 |
| Accessories | E-9 |

Commercial references

EasyPact EZS100

With TM-D thermal-magnetic trip unit

EasyPact EZS100E (25 kA at 380/415 V)

| Rating | 3P3d | 4P3d |
|--------|-------------|-------------|
| TM16D | EZS100E3016 | EZS100E4016 |
| TM20D | EZS100E3020 | EZS100E4020 |
| TM25D | EZS100E3025 | EZS100E4025 |
| TM32D | EZS100E3032 | EZS100E4032 |
| TM40D | EZS100E3040 | EZS100E4040 |
| TM50D | EZS100E3050 | EZS100E4050 |
| TM63D | EZS100E3063 | EZS100E4063 |
| TM80D | EZS100E3080 | EZS100E4080 |
| TM100D | EZS100E3100 | EZS100E4100 |

EasyPact EZS100F (30 kA at 380/415 V)

| Rating | 3P3d | 4P3d |
|--------|-------------|-------------|
| TM16D | EZS100F3016 | EZS100F4016 |
| TM20D | EZS100F3020 | EZS100F4020 |
| TM25D | EZS100F3025 | EZS100F4025 |
| TM32D | EZS100F3032 | EZS100F4032 |
| TM40D | EZS100F3040 | EZS100F4040 |
| TM50D | EZS100F3050 | EZS100F4050 |
| TM63D | EZS100F3063 | EZS100F4063 |
| TM80D | EZS100F3080 | EZS100F4080 |
| TM100D | EZS100F3100 | EZS100F4100 |

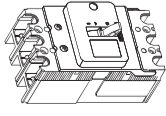

Connection accessories

Cable lugs



≤ 50A

Cables from 2.5 to 16 mm²

Set of 2

EZALUG0502

Set of 3

EZALUG0503



> 50A

Cables from 10 to 50 mm²

Set of 2

EZALUG1002

Set of 3

EZALUG1003

Spreaders



Spreaders for 3P breaker

Spreaders for 4P breaker

Set of 2

EZASPRDR3P

Set of 3

EZASPRDR4P

Terminal shields

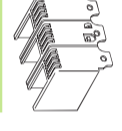

Spreaders for 3P breaker

Spreaders for 4P breaker

Set of 2

EZATSHD3P

Set of 3

EZATSHD4P



Phase barriers



Phase barriers

Set of 2

EZAFASB2

Electrical auxiliaries

Indication contacts

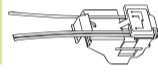

Auxiliary switch (AX)

EZAUX10

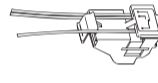

Alarm switch (AL)

EZAUX01

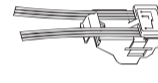

Auxiliary switch + alarm switch (AX + AL)

EZAUX11

Electrical auxiliaries (cont.)

Voltage releases

| | | |
|----|--|---|
| AC | Voltage 100 - 130V 200 - 277V | MX/SHT EZASHT100AC EZASHT200AC |
|----|--|---|

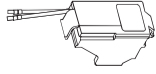

Shunt trip (SHT)

| | | |
|----|------------------------------|------------------------------|
| AC | Voltage 200 - 240V | MN/UVR EZAUVR200AC |
|----|------------------------------|------------------------------|

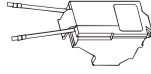

Undervoltage release (UVR)

Rotary handles

Direct rotary handle (for 3/4P breaker)

| | | |
|--|--|-----------------|
| | | EZAROTDS |
|--|--|-----------------|

Direct rotary handle (black)



Extended rotary handle (for 3/4P breaker)

| | | |
|--|--|----------------|
| | | EZAROTE |
|--|--|----------------|

Extended rotary handle (black)

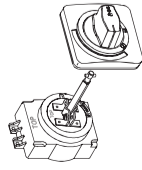

Commercial references

EasyPact EZS160

With TM-D thermal-magnetic trip unit
EasyPact EZS160E (25 kA at 380/415 V)

| | | |
|---------------|-------------|-------------|
| Rating | 3P3d | 4P3d |
| TM100D | EZS160E3100 | EZS160E4100 |
| TM125D | EZS160E3125 | EZS160E4125 |
| TM160D | EZS160E3160 | EZS160E4160 |

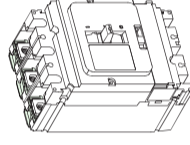

EasyPact EZS160F (36 kA at 380/415 V)

| | | |
|---------------|-------------|-------------|
| Rating | 3P3d | 4P3d |
| TM100D | EZS160F3100 | EZS160F4100 |
| TM125D | EZS160F3125 | EZS160F4125 |
| TM160D | EZS160F3160 | EZS160F4160 |

EasyPact EZS250

With TM-D thermal-magnetic trip unit

EasyPact EZS250E (25 kA at 380/415 V)

| | | |
|---------------|-------------|-------------|
| Rating | 3P3d | 4P3d |
| TM200D | EZS250E3200 | EZS250E4200 |
| TM225D | EZS250E3225 | EZS250E4225 |
| TM250D | EZS250E3250 | EZS250E4250 |

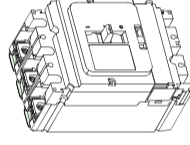

EasyPact EZS250F (36 kA at 380/415 V)

| | | |
|---------------|-------------|-------------|
| Rating | 3P3d | 4P3d |
| TM200D | EZS250F3200 | EZS250F4200 |
| TM225D | EZS250F3225 | EZS250F4225 |
| TM250D | EZS250F3250 | EZS250F4250 |

Connection accessories (Cu or Al)

Rear connections



| | |
|---------|----------|
| 2 short | LV429235 |
| 2 long | LV429236 |

Bare cable connectors



| | | | |
|------------------|---|----------|----------|
| Steel connectors | 1 x (1.5 to 95 mm ²); ≤ 160 A | Set of 3 | LV429242 |
| | | Set of 4 | LV429243 |

Terminal extensions

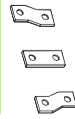

| | | |
|---|----------|----------|
| Spreaders from 35 to 45 mm pitch ⁽¹⁾ | Set of 3 | LV431563 |
| | Set of 4 | LV431564 |

Insulation accessories



| | | |
|-------------------------------------|-----|----------|
| 1 short terminal shield for breaker | 3 P | LV429515 |
| | 4 P | LV429516 |

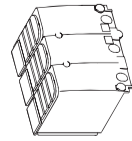

| | | |
|------------------------------------|-----|----------|
| 1 long terminal shield for breaker | 3 P | LV429517 |
| | 4 P | LV429518 |



| | | |
|---------------------------------|----------|----------|
| Interphase barriers for breaker | Set of 6 | LV429329 |
|---------------------------------|----------|----------|

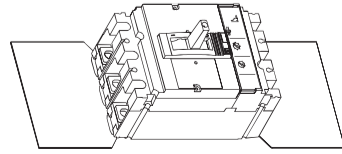

| | | |
|--|-----|----------|
| 2 insulating screens for breaker (45 mm pitch) | 3 P | LV429330 |
| | 4 P | LV429331 |

⁽¹⁾ Supplied with 2 or 3 interphase barriers.

Electrical auxiliaries

Auxiliary contacts (changeover)



| | |
|--------------------|-------|
| OF or SD | 29450 |
| OF or SD low level | 29452 |

Voltage releases



| | Voltage | MX | MN |
|----|--|----------|----------|
| AC | 110-130 V 50/60 Hz | LV429386 | LV429406 |
| | 220-240 V 50/60 Hz and 208-277 V 60 Hz | LV429387 | LV429407 |
| DC | 24 V | LV429390 | LV429410 |

Rotary handles

Direct rotary handle

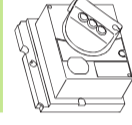

| | |
|-------------------|----------|
| With black handle | LV429337 |
|-------------------|----------|

Extended rotary handle

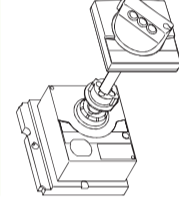

| | |
|-------------------|----------|
| With black handle | LV429338 |
|-------------------|----------|

Commercial references

EasyPact EZS400

With TM-D thermal-magnetic trip unit

EasyPact EZS400F (36 kA at 380/415 V)

| Rating | 3P3d | 4P3d |
|--------|-------------|-------------|
| TM315D | EZS400F3315 | EZS400F4315 |
| TM350D | EZS400F3350 | EZS400F4350 |
| TM400D | EZS400F3400 | EZS400F4400 |

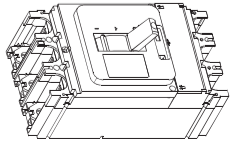

EasyPact EZS400N (50 kA at 380/415 V)

| Rating | 3P3d | 4P3d |
|--------|-------------|-------------|
| TM315D | EZS400N3315 | EZS400N4315 |
| TM350D | EZS400N3350 | EZS400N4350 |
| TM400D | EZS400N3400 | EZS400N4400 |

EasyPact EZS630

With TM-D thermal-magnetic trip unit

EasyPact EZS630F (36 kA at 380/415 V)

| Rating | 3P3d | 4P3d |
|--------|-------------|-------------|
| TM500D | EZS630F3500 | EZS630F4500 |
| TM600D | EZS630F3600 | EZS630F4600 |

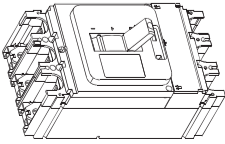

EasyPact EZS630N (50 kA at 380/415 V)

| Rating | 3P3d | 4P3d |
|--------|-------------|-------------|
| TM500D | EZS630N3500 | EZS630N4500 |
| TM600D | EZS630N3600 | EZS630N4600 |

Connection accessories (Cu or Al)

Rear connections



| | |
|---------|----------|
| 2 short | LV432475 |
| 2 long | LV432476 |

Cable connectors ⁽¹⁾



Aluminium connector 1x (35 to 300 mm²)

| | |
|----------|----------|
| Set of 3 | LV432479 |
| Set of 4 | LV432480 |

Terminal extension ⁽¹⁾



Spreaders 70 mm

| | |
|----|----------|
| 3P | LV432492 |
| 4P | LV432493 |

Insulation accessories

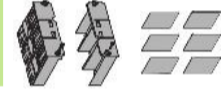

Short terminal shield, 45 mm (1 piece)

LV432591

Long terminal shield, 45 mm (1 piece)

LV432592

Interphase barriers

LV432593

Interphase barriers

LV432594

Interphase barriers

LV432570

⁽¹⁾ supplied with 2 or 3 interphase barriers.

Electrical auxiliaries

Auxiliary contacts (changeover)



OF or SD

29450

OF or SD low level

29452

Voltage releases

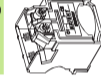

Voltage

MIN

MX

AC 110-130 V 50/60 Hz

LV429386

DC 220-240 V 50/60 Hz and 208-277 V 60 Hz

LV429387

24 V

LV429390

LV429410

Rotary handle

Direct rotary handle



Standard black handle

LV432597

Extended rotary handle

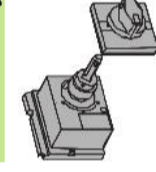

Standard extended rotary handle

LV432598

Life Is On | **Schneider**
Electric

Schneider Electric Industries SAS

35, rue Joseph Monier
CS 30323
92506 Rueil Malmaison Cedex
France

RCS Nanterre 954 503 439
Capital social 928 298 512 €
www.se.com

Sep-2020

© 2020 - Schneider Electric. All Rights Reserved.
All trademarks are owned by Schneider Electric Industries SAS or its affiliated companies.
Document reference LVED215011EN



This document has been
printed on recycled paper