

Tube Fitting

FITTING

PY Union Y

RoHS compliant

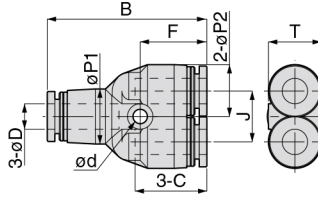

Unit : mm

Model code	Tube O.D. øD	B	øP1	øP2	Tube end C	J	ød	F	T	Orifice bore (ømm)	Weight (g)	CAD file name
PY4④	4	32.8	10	10	14.9	11	3.2	14.1	10.4	2.6	7.6	PY4
PY6④	6	37.7	13	12.5	17	12	3.4	15.8	13.5	4.3	11	PY6
PY8④	8	42.4	15	14.5	18.1	14	3.4	17.2	15.1	5.7	16	PY8
PY10④	10	48.4	17.5	17.5	20.7	18	4.2	19.5	18.2	6.7	26	PY10
PY12④	12	54.8	21	21	23.4	20	4.2	22.2	21.7	8	37	PY12
PY16④	16	62.2	25	25	24.1	24	4.5	22.1	25	12.7	45	PY16
PY5/32④	5/32	32.8	10	10	14.9	11	3.2	14.1	10.4	2.6	7.6	PY5_32
PY3/16④	3/16	38.5	13	12.5	17.4	12	3.4	16.2	13.5	3.8	11	PY3_16
PY1/4④	1/4	37.7	13	12.5	17	12	3.4	15.8	13.5	4.7	11	PY1_4
PY5/16④	5/16	42.4	15	14.5	18.1	14	3.4	17.2	15.1	5.7	16	PY5_16
PY3/8④	3/8	48.4	17.5	17.5	20.7	18	4.2	19.5	18.2	6.8	26	PY3_8
PY1/2④	1/2	55.4	21	21	23.7	20	4.2	22.5	21.7	7.9	35	PY1_2

※ 1. ④ in Model code / Replaced with "W" for Light-gray color, "-C" for Clean-room package, "W-C" for Light-gray color and Clean-room package, "-UC" for Clean-wash and Clean-room package

※ 2. Orifice bore is the smallest passage converted in terms of the diameter.

New
Line Up



Push-In Fitting Type for Pneumatic Piping Tube Fitting **Standard Series**

- *Push-in fitting for General Pneumatic Piping.*
- *Redesigned 17 models, realized weight saving.*
(PC, PCF, POC, PM, PMF, PL, PLL, PLH, PLF, PVX, PAX, PB, PD, PX, PRX, PKD, PKVD)
- *Wide Variety of Products.*
- *Rotatable Resin Body after Installation.*
- *Centralized Piping.*
Triple type (PKD, PKG, PKJ) and twin triple type (PKVD, PKVG) are compact designed to achieve centralized piping.
- *Optional Selection of Clean-Room Package and Clean-wash Package.*

Model Designation (Example)

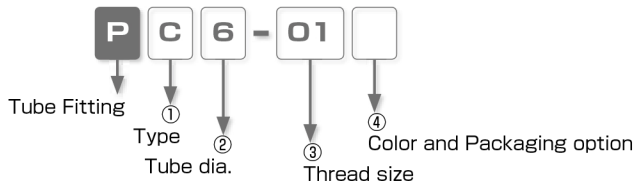

① Type

Code	Type	Code	Type	Code	Type	Code	Type
C	Straight	OC	Inner Hex. Straight	L	Elbow	LL	Long Elbow
LH	45° Elbow	H	Single Banjo	OL	Hex. Holed Banjo	B	Branch Tee
D	Run Tee	X	Branch Y	VX	Tripod Elbow	AX	Branch Elbow
A	Twin Banjo	RX	Double Branch Y	HW	Double Banjo	HT	Triple Banjo
AW	Double Twin Banjo	AT	Triple Twin Banjo	CF	Female Straight	MF	Bulkhead Female Straight
LF	Female Elbow	KD	Triple Run Tee	KVD	Twin Triple Run Tee	AF	Link-up Twin Banjo
HF	Link-up Banjo	U	Union Straight	E	Union Tee	V	Union Elbow
Y	Union Y	M	Bulkhead Union	MP	Bulkhead Union P	ML	Bulkhead Union Elbow
VU	Tripod Union	AU	Branch Union Elbow	ZA	Union Cross	G	Unequal Union Straight
EG	Unequal Union Tee	RG	Unequal Double Y	W	Unequal Union Y	KG	Unequal Triple Tee
KVG	Unequal Twin Triple Tee	ZB	Unequal Cross	ZC	Reducing Cross	GJ	Unequal Plug-in Straight
LJ	Plug-in Elbow	LGJ	Unequal Plug-in Elbow	LLGJ	Unequal Plug-in Long Elbow	LHJ	45° Plug-in Elbow
LLJ	Long Plug-in Elbow	YJ	Plug-in Y	WJ	Unequal Plug-in Y	KJ	Plug-in Triple Tee
RJ	Plug-in Double Y	F	Extension Screw Adaptor	FF	Unequal Screw Union	IJ	Union Stem
IG	Unequal Union Stem	TJ	PT Jack	PF	Cap	P	Plug

※ [Grey] parts are redesigned models.

② Tube dia. (※ In case that ② indicates thread, select thread size from table ③)

Tube dia. Code	mm size						inch size						
	4	6	8	10	12	16	5/32	3/16	1/4	5/16	3/8	1/2	5/8
Size (mm)	ø4	ø6	ø8	ø10	ø12	ø16	ø3.97	ø4.76	ø6.35	ø7.94	ø9.53	ø12.7	ø15.88

③ Thread size (※ In case that ③ indicates tube dia., select tube dia. from table ②)

Thread size Code	Metric thread (mm)		Taper pipe thread			
	M5	M6	01	02	03	04
Size	M5 × 0.8	M6 × 1	R1/8	R1/4	R3/8	R1/2

Thread size Code	UNF thread (mm)		NPT thread			
	U10U	N1U	N2U	N3U	N4U	N0U
Size	10-32UNF	NPT1/8	NPT1/4	NPT3/8	NPT1/2	NPT1/16

※ The unit of wrench size is inch (the code suffix is "U").

④ Color and Packaging option

Code	Color and Package classification	Color Combination		Remark
		Release ring (※)	Fitting body	
No code	Std.	Black	Black	
-C	Clean-room package	Light-blue	Light-gray	Optional selection
W	Light-gray	Light-gray	Light-gray	Optional selection
W-C	Light-gray + Clean-room pkg.	Light-gray	Light-gray	Optional selection
-UC	Clean-wash and Clean-room pkg.	Light-blue	Light-gray	Optional selection

※ . Release-ring color is white for inch-size products.

Specifications

Fluid medium	Air / Water (※)
Max. operating pressure	1.0MPa
Max. vacuum	-100kPa
Operating temp. range	0 ~ 60°C (No freezing)

⚠ Warning

- ※ . Make sure to follow the instructions below when the fluid medium is water.
1. Surge pressure must be controlled lower than max. operating pressure.
 2. Tap water can be used. Consult with PISCO for using other kind of water.
 3. Be sure to place Insert Ring into the tube edge when using water as a fluid medium.

Construction (Elbow: PL)

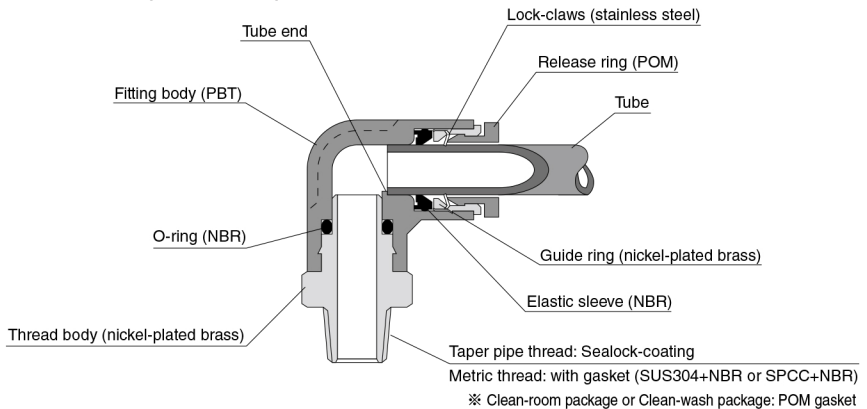

⚠ Detailed Safety Instructions

Before using PISCO products, be sure to read "Safety Instructions" and "Common Safety Instructions for Products Listed in This Catalog" on page 23 to 28 and "Common Safety Instructions for Fittings" on page 33 to 34.

Warning

1. When the fluid medium is water, do not use Tube Fitting Standard Series unless the operating environment meets all the described specifications in the catalog. Otherwise, it may cause damage to the products, the escape of tubes and a fluid leakage.

Caution

1. To adjust the direction of the elbow fitting after fixing PML (Bulkhead Union Elbow) type, turn it in the clock-wise (right) direction.
2. Attach a rubber washer to the aluminum nut side when installing PML (Bulkhead Union Elbow) type. The bulkhead parts may be loosened or the rubber washer may deform if attaching it to the hexagonal side.

Caution (Clean-room package, clean-wash package)

1. As for Push-In Fitting, the functional part where tube is inserted may slightly slide due to an internal pressure change and this may generate dusts. Avoid using the fitting in the clean room of ISO class from 1 to 5. Under the vibrating condition, check the amount of dust generated from the fitting and tubes, by using actual facilities.

Caution (Clean-wash package)

1. Tube insertion into the push-in fitting with clean-wash spec. is tighter than that of standard spec. due to its oil-free specification. Make sure to insert tube up to tube end.

How to insert and disconnect

1. How to insert and disconnect tubes

① Tube insertion

Insert a tube into Push-in fitting up to the tube end. Lock-claws bite the tube and fix it automatically, then the elastic sleeve seals around the tube.

Refer to "6. Instructions for Tube Insertion" under "Common Safety Instructions for Products Listed in This Catalog".

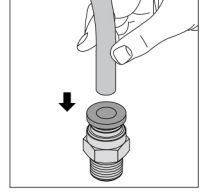

② Tube disconnection

The tube is disconnected by pushing release-ring to release Lock-claws.

Make sure to stop air supply before the tube disconnection.

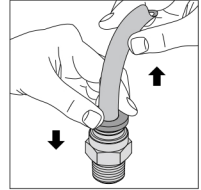

2. How to tighten thread

① Tightening thread

There are two ways to tighten thread. Use a spanner or an impact wrench for a hexagonal-column. A hex key is for an inner hexagonal socket. Inner hexagonal type can save spaces.

Refer to "Table 2: Tightening torque / Sealock color / Gasket materials" under "8. Instructions for Installing a fitting" in "Common Safety Instructions for Products Listed in This Catalog".

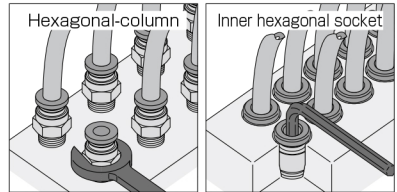

Applicable Tube and Related Products

Polyurethane Tube.....P.596

Nylon Tube.....P.608

Fluororesin Tube with clean-room package.....P.638

Polyurethane Tube with clean-room package.....P.642

Safety Instructions

This Safety Instructions aim to prevent personal injury and damage to properties by requiring proper use of PISCO products.

Be certain to follow ISO 4414 and JIS B 8370.

ISO 4414 : Pneumatic fluid power...General rules and safety requirements for system and their components.

JIS B 8370: General rules and safety requirements for systems and their components.

This Safety instructions are classified into "Danger", "Warning" and "Caution", depending on the degree of danger or damages caused by improper use of PISCO products.

 **Danger** Hazardous conditions. It can cause death or serious personal injury.

 **Warning** Hazardous conditions depending on usages. Improper Use of PISCO products can case death or serious personal injury.

 **Caution** Hazardous conditions depending on usages. Improper use of PISCO products can cause personal injury or damages to properties.

Warning

1. Selection of pneumatic products.

- ① A user who is a pneumatic system designer or has sufficient experience and technical expertise should select PISCO products.
- ② Due to wide variety of operating conditions and applications for PISCO products, carry out the analysis and evaluation on PISCO products. The pneumatic system designer is solely responsible for assuring that the user's requirements are met and that the application presents no health or safety hazards. All designers are required to fully understand the specifications of PISCO products and constitute all systems based on the latest catalog or information, considering any malfunction.

2. The pneumatic equipments shall be handled by a person having enough knowledge and experiences.

- ① Improper use of compressed air is dangerous. Assembly, operation and maintenance of machines using pneumatic equipment should be conducted by a person with enough knowledge and experience.

3. Do not operate machine / equipment or remove pneumatic equipment until safety is confirmed.

- ① Make sure that preventive measures against falling work-pieces or sudden movements of machine are completed before inspection or maintenance of these machine
- ② Make sure the above preventive measures are completed. A compressed air supply and the power supply to the machine must be off, and also the compressed air in the systems must be exhausted.

- ③ Restart the machines with care after ensuring to take all preventive measures against sudden movements.

Warranty

1. When the product produces a trouble, which is caused by our responsibility, we will carry out either one of the following measures immediately.
 - ① Free-of-charge replacement of same product
 - ② Free-of-charge repair of the product at our factory

Disclaimer

When a cause of the trouble/malfunction applies to any of the following items, it is excluded from the coverage of the above warranty.

- ①. A case by a natural disaster, a fire except our responsibility, the act by the third person/party, the intention or fault of the customer.
- ②. A case when a product is used out of the specific range or in a method listed in the product catalog or the instruction manual.
- ③. A case by the remodeling of the product or by a change of structure, performance, or specifications which PISCO is not involved in.
- ④. A case by the event that is unpredictable by the evaluations and the measures at the time on or before the initial delivery.
- ⑤. A case caused by the phenomenon that is able to be evaded if your machine or equipment has functions or structures that are comprised in a common sense when this product is incorporated in your machine or equipment.

Additionally, the above warranty is limited simply to the product itself. The damage induced by the trouble of the product will not be compensated.



Common Safety Instructions for Products Listed in This Catalog

PISCO products are designed and manufactured for use in general industrial machines.

Danger

1. Do not use PISCO products for the following applications.
 - ① Equipment used for maintaining / handling human life and body.
 - ② Equipment used for moving / transporting human.
 - ③ Equipment specifically used for safety purposes.

Warning

1. Do not use PISCO products under the following conditions.
 - ① Beyond the specifications or conditions stated in the catalog, or the instructions.
 - ② Use at outdoors.
 - ③ Excessive vibrations and impacts.
 - ④ Exposure / adhere to corrosive gas, flammable gas, chemicals, seawater, water and vapor.
 - * Some products can be used under the condition above(④). Refer to the details of specifications and conditions of each product.
2. Do not disassemble or modify PISCO products, which affect the performance, function, and basic structure of the product.
3. Do not touch the release-ring of a push-in fitting when there is a working pressure. The lock may be released by the physical contact, and tube may fly out or slip out.
4. Frequent switchover of compressed air may generate heat, and there is a risk of causing burn injury.
5. Avoid any load on PISCO products, such as, a tensile strength, twisting and bending.
6. As for applications where threads or tubes swing / rotate, use Rotary Joints, High Rotary Joints or Multi-Circuit Rotary Block only. The other PISCO products can be damaged in these applications.
7. Use only Die Temperature Control Fitting Series, Tube Fitting Stainless SUS316 Series, Tube Fitting Stainless SUS316 Compression Fitting Series or Tube Fitting Brass Series under the condition of over 60°C (140 °F) water or heat medium oil. Other PISCO products can be damaged by heat and hydrolysis under the condition above.
8. As for the condition required to dissipate static electricity or provide an antistatic performance, use EG series fitting and antistatic products only, and do not use other PISCO products. There is a risk that static electricity

can cause system defects or failures.

9. Use only Fittings with a characteristic of spatter-proof such as Anti-spatter or Brass series in a place where flame and weld spatter is produced. There is a risk of causing fire by sparks.
10. Turn off the power supply, stop the air supply to PISCO products, and make sure there is no residual air pressure in the pipes before maintenance and inspection. Follow the instructions below in order to ensure the safety.
 - ① Make sure the safety of all systems related to PISCO products before maintenance.
 - ② Restart of operation after maintenance shall be proceeded with care after ensuring the safety of the system by preventive measures against unexpected movements of machines and devices where pneumatic equipment is used.
 - ③ Keep enough space for maintenance when designing a circuit.
11. Take safety measures such as providing a protection cover if there is a risk of causing damages or fire on machine / facilities by a fluid leakage.

Caution

1. Remove dusts or drain before piping. They may get into the peripheral machine / facilities and cause malfunction.
2. When inserting an ultra-soft tube into a push-in fitting, make sure to place an Insert Ring into the tube edge. There is a risk of causing the escape of the tube and a fluid leakage without using an Insert Ring.
3. The product incorporating NBR as seal rubber material has a risk of malfunction caused by ozone crack. Ozone exists in high concentrations in static elimination air, clean-room, and near the high-voltage motors, etc. As a countermeasure, material change from NBR to HNBR or FKM is necessary.
4. Special option "Oil-free" products may cause a very small amount of a fluid leakage. When a fluid medium is liquid or the products are required to be used in harsh environments, contact us for further information.
5. In case of using non-PISCO brand tubes, make sure the tolerance of the outer tube diameter and tube hardness are within the limits of Table 1.

● Table 1. Tube O.D. Tolerance

mm size	Nylon tube (SHORE D63)	Polyurethane tube (SHORE A98)	inch size	Nylon tube (SHORE D63)	Polyurethane tube (SHORE A98)
ø1.8mm	—	± 0.05mm	ø1/8	± 0.1mm	± 0.15mm
ø2mm	—	± 0.05mm	ø5/32	± 0.1mm	± 0.15mm
ø3mm	—	± 0.15mm	ø3/16	± 0.1mm	± 0.15mm
ø4mm	± 0.1mm	± 0.15mm	ø1/4	± 0.1mm	± 0.15mm
ø6mm	± 0.1mm	± 0.15mm	ø5/16	± 0.1mm	± 0.15mm
ø8mm	± 0.1mm	± 0.15mm	ø3/8	± 0.1mm	± 0.15mm
ø10mm	± 0.1mm	± 0.15mm	ø1/2	± 0.1mm	± 0.15mm
ø12mm	± 0.1mm	± 0.15mm	ø5/8	± 0.1mm	± 0.15mm
ø16mm	± 0.1mm	± 0.15mm			

6. Instructions for Tube Insertion

- ① Make sure that the cut end surface of the tube is at a right angle without a scratch on the tube surface or deformations.
- ② When inserting a tube, the tube needs to be inserted fully into the push-in fitting until the tubing edge touches the tube end of the fitting as shown in the figure below. Otherwise, there is a risk of leakage.

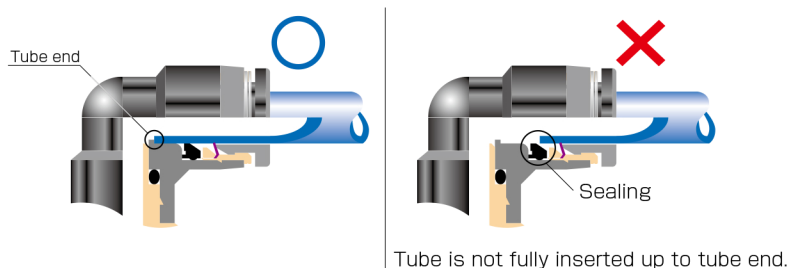

- ③ After inserting the tube, make sure it is inserted properly and not to be disconnected by pulling it moderately.
- ※. When inserting tubes, Lock-claws may be hardly visible in the hole, observed from the front face of the release-ring. But it does not mean the tube will surely escape. Major causes of the tube escape are the followings; ① Shear drop of the lock-claws edge ② The problem of tube diameter (usually small). Therefore, follow the above instructions from ① to ③, even lock-claws is hardly visible.

7. Instructions for Tube Disconnection

- ① Make sure there is no air pressure inside of the tube, before disconnecting it.
- ② Push the release-ring of the push-in fitting evenly and deep enough to pull out the tube toward oneself. By insufficient pushing of the release-ring, the tube may not be pulled out or damaged by scratch, and tube shavings may remain inside of the fitting, which may cause the leakage later.

8. Instructions for installing a fitting

- ① When installing a fitting, use proper tools to tighten a hexagonal-column or an inner hexagonal socket. When inserting a hex key into the inner hexagonal socket of the fitting, be careful so that the tool does not touch lock-claws. The deformation of lock-claws may result in a poor performance of systems or an escape of the tube.
- ② Refer to Table 2 which shows the tightening torque. Do not exceed these limits to tighten a thread. Excessive tightening may break the thread part or deform the gasket to cause a fluid leakage. Tightening thread with tightening torque lower than these limits may cause a loosened thread or a fluid leakage.
- ③ Adjust the tube direction while tightening thread within these limits, since some PISCO products are not rotatable after the installation.

● Table 2: Tightening torque / Sealock color / Gasket materials

Thread type	Thread size	Tightening torque	Sealock color	Gasket material
Metric thread	M3 × 0.5	0.7N·m	—	SPCC+NBR SUS304+NBR
	M5 × 0.8	1 ~ 1.5N·m		
	M6 × 1	2 ~ 2.7N·m		
	M3 × 0.5	0.7N·m		POM
	M5 × 0.8	1 ~ 1.5N·m		
	M6 × 0.75	0.8 ~ 1N·m		
	M8 × 0.75	1 ~ 2N·m		
Taper pipe thread	R1/8	4.5 ~ 6.5N·m	White	—
	R1/4	7 ~ 9N·m		
	R3/8	12.5 ~ 14.5N·m		
	R1/2	20 ~ 22N·m		
Unified thread	No.10-32UNF	1 ~ 1.5N·m	—	SPCC+NBR, SUS304+NBR
National Pipe Thread Taper (American standard)	1/16-27NPT	4.5 ~ 6.5N·m	White	—
	1/8-27NPT	4.5 ~ 6.5N·m		
	1/4-18NPT	7 ~ 9N·m		
	3/8-18NPT	12.5 ~ 14.5N·m		
	1/2-14NPT	20 ~ 22N·m		

※ These values may differ for some products. Refer to each specification as well.

9. Instructions for removing a fitting

- ① When removing a fitting, use proper tools to loosen a hexagonal-column or an inner hexagonal socket. When inserting a hex key into the inner hexagonal socket of the fitting, be careful so that the tool does not touch lock-claws. The deformation of lock-claws may result in a poor performance of systems or an escape of the tube.
- ② Remove the sealant stuck on the mating equipment. The remained sealant may get into the peripheral equipment and cause malfunctions.

10. Arrange piping avoiding any load on fittings and tubes such as twist, tensile, moment load, shaking and physical impact. These may cause damages to fittings, tube deformations, bursting and the escape of tubes.

11. Instructions for handling a fitting

- ① Impact caused by dropping or the like may lead to damage to the product and a fluid leakage.

⚠ Common Safety Instructions for Fittings

Before selecting or using PISCO products, read the following instructions. Read the detailed instructions for individual series.

⚠ Warning

1. Use PISCO products within the range of the specifications for each series. Consult with PISCO for use outside the specifications.

⚠ Caution









1. A bulkhead nut of Bulkhead Union (PM), Bulkhead Union P (PMP), and Bulkhead Union Elbow (PML) should be tightened within the specified tightening torque range.

● Bulkhead nut tightening torque

Series	Tube size	Tightening torque	
		Bulkhead Union (PM)	Bulkhead Union P (PMP), Bulkhead Union Elbow (PML)
Tube Fitting	4	12.0 ~ 14.0N·m	0.4 ~ 0.6N·m
	6	18.0 ~ 21.0N·m	0.9 ~ 1.1N·m
	8	18.0 ~ 21.0N·m	1.1 ~ 1.3N·m
	10	19.0 ~ 21.0N·m	2.3 ~ 2.7N·m
	12	19.0 ~ 21.0N·m	2.7 ~ 3.3N·m
	16	42.0 ~ 54.0N·m	—
Tube Fitting Mini	1.8	0.8 ~ 1.0N·m	—
	2	0.8 ~ 1.0N·m	
	3	2.5 ~ 3.5N·m	
	4	5.0 ~ 7.0N·m	
	6	12.0 ~ 14.0N·m	

2. If an object between the bulkhead nut and fitting body is deformable or has oil on its surface, the nut may loosen after tightening.
3. PISCO pneumatic fittings are designed for use with tube inserted. Air supply without tube insertion such as air flushing may cause an elastic sleeve to fly out of the fitting.

Identification of fittings

Tube Fitting Standard	Tube Fitting Standard Clean-room Package
 <p>Fitting body : Black</p> <p>Release ring : Black</p>	 <p>Fitting body : Light-gray</p> <p>Release ring : Light-blue</p>
Tube Fitting Mini	Tube Fitting Mini Clean-room Package
 <p>Fitting body : Black</p> <p>Release ring : Black</p>	 <p>Fitting body : Light-gray</p> <p>Release ring : Light-blue</p>
Tube Fitting Stainless SUS303 Equivalent Corrosivity	Tube Fitting Stainless SUS304
 <p>Guide ring : Without V groove</p> <p>Fitting body : Black</p> <p>Release ring : Dark blue</p> <p>Thread body : Without Flat groove on the hexagonal column</p>	 <p>Guide ring : With V groove</p> <p>Fitting body : Black</p> <p>Release ring : Dark blue</p> <p>Thread body : With Flat groove on the hexagonal column</p>
Tube Fitting PP (Thread material : PP)	Tube Fitting PP (Thread material : SUS304)
 <p>Fitting body : Translucent</p> <p>Release ring : Translucent</p> <p>Thread body : Resin thread</p>	 <p>Fitting body : Translucent</p> <p>Release ring : Translucent</p> <p>Thread body : Metal thread</p>

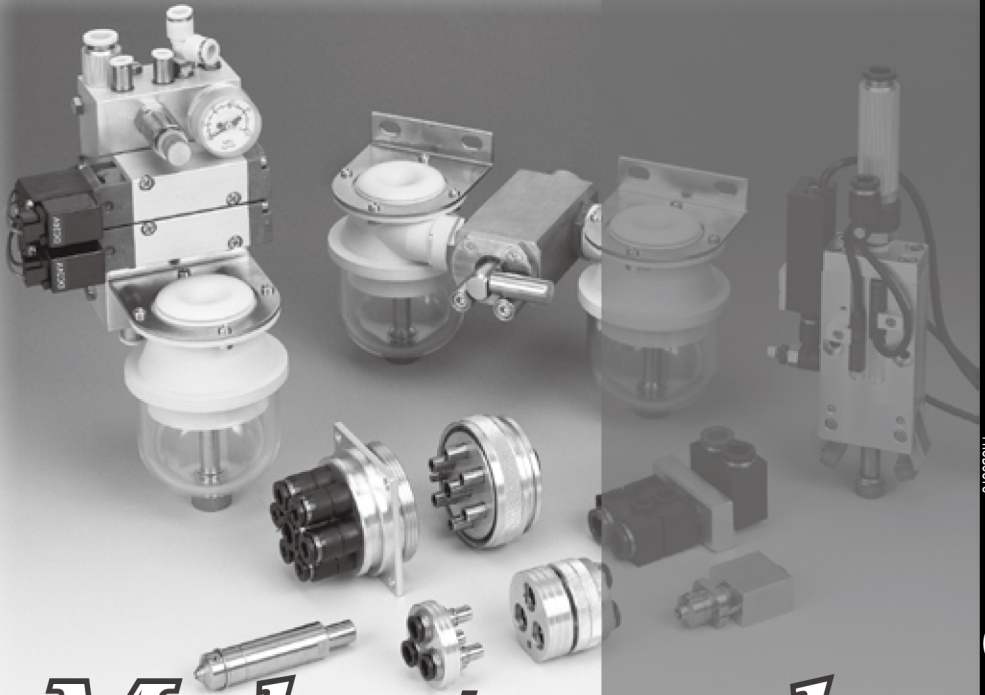

Make-to-order products

PISCO offers make-to-order products to support customer's various requirements such as special specifications, and special appearances.

Special Options

■ Characteristics

● *Color option*

Light-gray color option for resin body and release-ring.

● *Seal rubber material option*

Seal Rubber Selection: FKM or EPDM.

● *Oil-free option*

Suitable for Oil-free Environment.

● *Release-ring color option*

Changeable to Red Color

● *Non-purple option*

Suppress CU ion and F ion.

※ Note: With this option, Check Valve and Stop Fitting, etc. do not have marking on the brass parts. Be careful when piping.

Model Designation (Example)

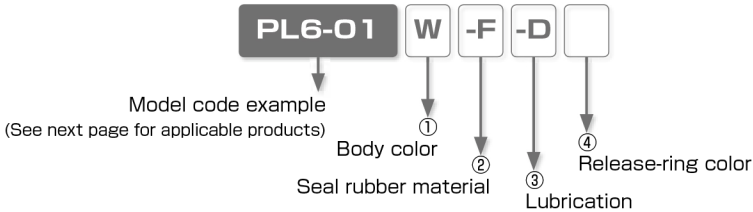

① Body color

Code	W	No code
Body color	Light-gray	Standard color

※ . W: Release-ring color is light-gray

② Seal rubber material

Code	-F	-E	-HN	No code
Material	FKM	EPDM (Oil-free)	HNBR	Standard seal rubber

※ 1. FKM: Release-ring color is brown. Non-purple option is not available with FKM option.

※ 2. EPDM: All oil-free. Release-ring color is yellow.

※ 3. EPDM: Not available for Thread size M3, M6 and Fittings with Inch sized Tube dia.

③ Lubrication

Code	-D	-P	No code
Option	Oil-free	Non-purple	Standard lubrication

※ 1. Oil-free : Release-ring color is yellow.

※ 2. The products with oil-free option are assembled without intentional use of lubrication through its production process. It may cause problems such as degradation of airtightness and increase of friction.

※ 3. Non-purple option is not available with FKM option. No sealcoat is provided on the thread.

④ Release-ring color

Code	-RR	No code
Color	Red	Standard color

※ . See next page for "Reference Chart of Special Option" .

※ . Contact the nearest sales office for the price.

Reference Chart of Special Option

























































○ : Available, × : Not available

Series	Standard specification						Special specification										
	Body Color and Packaging / Cleaning option	Body color	Release-ring color	Seal rubber material	Lubrication	Thread sealing	①		②		③		④				
							Light-gray	FKM	EPDM	HNBR	Oil-free	Non-Purple	Red				
							W*1	-F*2	-E*3	-HN	-D*4	-P*2	-RR				
Tube Fitting Standard Series	Standard	Black	Black	NBR	Turbin oil	With sealock coat	×	○*5	○	○	○	○	○				
	Light-gray	Light-gray	Light-gray				Std. option	○	○*6	○	○*6	○	×	×			
	Clean-room Pkg	Light-gray	Light-blue				○	○	○	○	○	×	×	○			
	Clean washing + Clean-room pkg	Light-gray	Light-blue				Oil-free	×	×	○*6	Std. option	○	○	○			
Tube Fitting Mini Series	Standard	Black	Black	NBR	Turbin oil	With sealock coat	×	○*5,*10	○*10	○	○	○	○				
	Light-gray	Light-gray	Light-gray				Std. option	○*10	○*10	○	○*6	○	×	×			
	Clean-room Pkg	Light-gray	Light-blue				○	○*10	○*10	○	○	×	×	○			
	Light-gray + Clean-room pkg	Light-gray	Light-gray				Std. option	○*10	○*10	○	○	○	×	×			
Tube Fitting Stainless SUS304 Series	—	Black	Dark-blue	FKM	Turbin oil	With sealock coat	×	Std. option	○*7	○	○*7	×	—				
Tube Fitting Stainless SUS303 Equiv. corrosivity	Standard	Black	Dark-blue	HNBR	Turbin oil	With sealock coat	○	○	○*7	Std. option	○*7	○	○				
	Clean washing + Clean-room pkg	Black	Dark-blue				Oil-free	×	×	○	○	Std. option	×	○			
Tube Fitting EG Series	—	Black	Black	NBR	Turbin oil	With sealock coat	×	○	○*8	○	○*8	○	—				
Tube Fitting Brass Series	—	—	—	HNBR	Turbin oil	With sealock coat	×	—	×	Std. option	○	○	×				
				FKM				—		—	○	○	×				
				NBR				—		—	○	○	×				
Tube Fitting Long Series	—	—	Black	NBR	Turbin oil	With sealock coat	×	○*5	○	○	○	○	○				
Main Block	Standard	Black	Black	NBR	Turbin oil	With sealock coat	×	○*5	○	○	—	×	○				
	Light-gray	Light-gray	Light-gray				Std. option	○	○	○	○	○	○				
Connector	—	Black	Black	NBR	Turbin oil	—	×	○*5	○	○	○	×	○				
Speed Controller Series	Standard	Black	Black	NBR	Turbin oil	With sealock coat	×	○*13	○*10	○*10,*11	—	○	○				
	Light-gray	Light-gray	Light-gray				Std. option	○	○*10,*11					○	○		
	Clean-room Pkg	Light-gray	Light-blue				×	○*10,*11	○*10,*11					○	○	×	×
	Light-gray + Clean-room pkg	Light-gray	Light-gray				Std. option	*12	○*10					○	○	×	×
Speed Controller SUS303 Equiv. corrosivity	—	Black	Dark-blue	HNBR	Turbin oil	With sealock coat	○	○*11,*12	○*7	Std. option	—	○	○				
Needle Valve Series	Standard	Black	Black	NBR	Turbin oil	With sealock coat	×	○*5,*12	○	○	—	○	○				
	Light-gray	Light-gray	Light-gray				Std. option	○	○					○	○		
	Clean-room Pkg	Light-gray	Light-blue				×	○*12	○*6					○	×	×	
	Light-gray + Clean-room pkg	Light-gray	Light-gray				Std. option	○	○					○	×	×	
Fixed orifice joint Series	—	Black	Black	NBR	Turbin oil	With sealock coat	○	○	○	○	○	○	○*9				
Regulator	—	Black	Black	NBR	Turbin oil	With sealock coat	×	×	×	×	×	○	○				
Check Valve (metal body)	—	—	Black	NBR	Turbin oil	With sealock coat	×	×	×	×	×	○	○				
Check Valve (resin body)	—	Light-gray	Light-gray				Std. option	○	×	×	—	○	○				
Low cracking pressure Check Valve	—	Light-gray	Light-gray	HNBR (Elastic sleeve)	Turbin oil	—	Std. option	○ (Elastic sleeve)	○ (Elastic sleeve)	Std. option	○	×	○				
				FKM (Propel valve packing)				×	×					×			

*1. When light-gray (-W) is selected for body color, the release-ring color of metric (mm) tube dia. is light-gray even for combination with any other options, except when Red color (-RR) is selected.
 *2. Non-purple (-P) option is not available with seal rubber material FKM. No Sealock coating for Non-purple option.
 *3. For EPDM (-E) specification of sealing material, the product is assembled as oil-free specification. The color of release-ring of metric (mm) tube size is yellow, except the combination with light-gray specification, which has light-gray release-ring. EPDM (-E) specification is not available for the products with M3 or M6 threads or inch tube dia.
 *4. Release-ring color: Yellow. When with light-gray specification, the release-ring color is light-gray.

*5. Release-ring color: Brown.
 *6. Release-ring color: Light-blue.
 *7. Release-ring color: Dark-blue.
 *8. Release-ring color: Black
 *9. Release-ring color: Red is not available with body color Light-gray.
 *10. Not available for Tube dia. ø1.8mm and ø2mm.
 *11. Not available for Low cracking pressure type.
 *12. Not available for the products with M3 thread.
 *13. See *5, *10, *11 and *12.
 *14. Applicable types: JSC, JSS and JSM for Standard Series, JSC-H for High Flow Series, JSC-L and JSS-L for Low Flow Series, JKC and JKL for Constant Flow Series.

Reference chart of Appearance Color Combination with Special Options (Fitting with Metal body)



Series	Resin color or Option	Tube dia. size		Seal rubber material		Lubrication	Release-ring color
				-F	-E	-D	-RR
				FKM	EPDM	Oil-free	Red
Tube Fitting Standard Series Tube Fitting Mini Series	-	(mm size)					
		(inch size)					
	Light-gray	(mm size)					
	Clean-room Pkg	(mm size)					
		(inch size)					
	Light-gray + Clean-room pkg	(mm size)					
Tube Fitting Standard Series	Clean washing + Clean-room pkg	(mm size)				Std. option	
		(inch size)				Std. option	
Tube Fitting Stainless SUS304 series	-	(mm size)		Std. option			
Tube Fitting Stainless SUS303 Equiv. corrosivity	-	(mm size)					
	Light-gray	(mm size)					
	Clean washing + Clean-room pkg	(mm size)				Std. option	

Reference chart of Appearance Color Combination with Special Options (Fitting with Resin body)

Series	Resin color or Option	Tube dia. size	Seal rubber material		Lubrication	Release-ring color		
			-F	-E	-D	-RR		
			FKM	EPDM	Oil-free	Red		
Tube Fitting Standard Series Tube Fitting Mini Series Clean-room Pkg Light-gray + Clean-room pkg	-	(mm size)						
		(inch size)						
	Light-gray	(mm size)						
		(inch size)						
	Clean-room Pkg	(mm size)						
		(inch size)						
	Light-gray + Clean-room pkg	(mm size)						
	Clean washing + Clean-room pkg	(mm size)				Std. option		
		(inch size)				Std. option		
	Stainless SUS304 series	-	(mm size)		Std. option			
	Tube Fitting Stainless SUS303 Equiv. corrosivity	-	(mm size)					
			Light-gray	(mm size)				
Clean washing + Clean-room pkg		(mm size)				Std. option		

※ Consult PISCO for any inquiry of special-made product, which is not listed in this catalog.

Reference chart of Appearance Color Combination with Special Options (Speed controller and Needle Valve)

Series	Resin color or Option	Tube dia. size		Seal rubber material		Release-ring color
				-F	-E	-RR
				FKM	EPDM	Red
Speed Controller Series Needle Valve Series	-	(mm size)				
		(inch size)				
	Light-gray	(mm size)				
		(inch size)				
	Clean-room Pkg	(mm size)				
		(inch size)				
	Light-gray + Clean-room pkg	(mm size)				

Space-Saving Options

■ Characteristics

- Suitable for Installing in Limited Spaces.

■ Model Designation (Example)

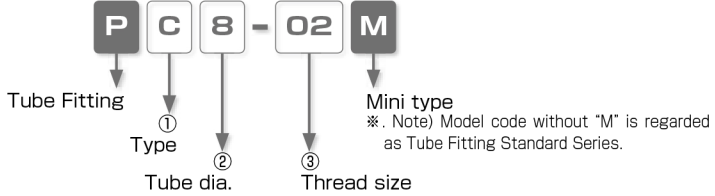

① Type

Code	Type	Code	Type	Code	Type
L	Elbow	B	Branch Tee	D	Run Tee

② Tube dia.

Code	8	10
Size (mm)	ø8	ø10

③ Thread size

Thread size	Taper pipe thread		
Code	01	02	03
Size	R1/8	R1/4	R3/8

PL
Mini Elbow

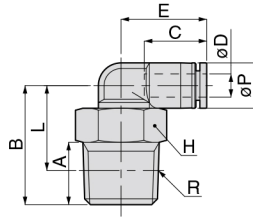

Unit : mm

Model code	Tube O.D. øD	R	A	B	Tube end C	L	Hex. H	E	øP	Weight (g)
PL8-01M	8	R1/8	8	22.5	18.1	18.5	12	21.9	15	11.9
PL8-02M		R1/4	11	25.5		19.5	14			17.5
PL8-03M		R3/8	12	26.5		20.2	17			27.9
PL10-02M	10	R1/4	11	27	20.2	21	14	24.4	18	20.9
PL10-03M		R3/8	12	28		21.7	17			28.8

※ . "L" is a reference value for height dimension after tightening thread.

MAKE TO ORDER PRODUCTS

762

PB
Mini Branch Tee

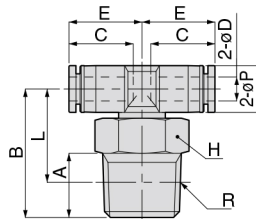

Unit : mm

Model code	Tube O.D. øD	R	A	B	Tube end C	L	Hex. H	E	øP	Weight (g)
PB8-01M	8	R1/8	8	22.5	18.1	18.5	12	21.9	15	12.8
PB8-02M		R1/4	11	25.5		19.5	14			18.2
PB8-03M		R3/8	12	26.5		20.2	17			26.1
PB10-02M	10	R1/4	11	27	20.2	21	14	24.4	18	22.3
PB10-03M		R3/8	12	28		21.7	17			30.4

※ . "L" is a reference value for height dimension after tightening thread.

TUBE VALVE CONTROLLER FITTING



Run Tee

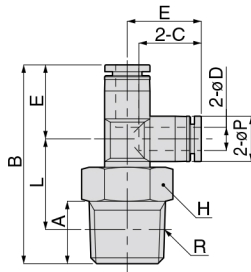

Unit : mm

Model code	Tube O.D. øD	R	A	B	Tube end C	L	Hex. H	E	øP	Weight (g)
PD8-01M	8	R1/8	8	44.2	18.1	18.5	12	21.7	15	11.9
PD8-02M		R1/4	11	47.2		19.5	14			17.5
PD8-03M		R3/8	12	48.2		20.2	17			25.3
PD10-02M	10	R1/4	11	52.3	20.2	21	14	25.3	18	21
PD10-03M		R3/8	12	53.3		21.7	17			28.8

※ 'L' is a reference value for height dimension after tightening thread.

MAKE-TO-ORDER PRODUCTS