

NYLON-INSULATED TWIN CORD END TERMINALS (TE SERIES)

MAXIMUM ELECTRIC CURRENT:







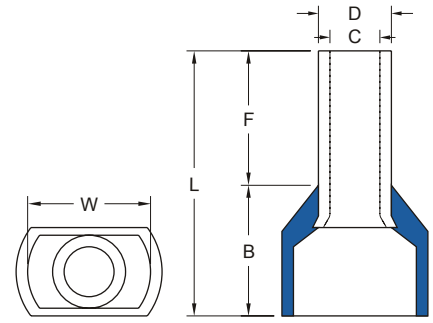

A.W.G.	8	6
AMP.	70	95

MAXIMUM ELECTRICAL RATING: 105°C 600 VOLTS MAX.

CONNECTOR MATERIAL: COPPER TUBE.

INSULATION MATERIAL: NYLON



WIRE RANGE A.W.G. mm ²	ITEM NO.	DIMENSION <small>inch mm</small>						FRENCH COLOR	GERMAN COLOR	DIN COLOR	CRIMPING TOOL
		F	L	W	B	D	C				
2X10 A.W.G. 2X6 mm ²	TE6014	.551 14.0	1.028 26.1	.374 9.5	.476 12.1	.209 5.3	.193 4.9	GREEN 	BLACK 	YELLOW 	K.S. MODEL KST8000-TC1208 WITH DIE INDEX NO.:2*10A
2X8 A.W.G. 2X10 mm ²	TE10-14	.551 14.0	1.047 26.6	.500 12.7	.496 12.6	.272 6.9	.256 6.5	BROWN 	IVORY 	RED 	K.S. MODEL KST8000-TC1208 WITH DIE INDEX NO.:2*8A
2X6 A.W.G. 2X16 mm ²	TE16-14	.551 14.0	1.232 31.3	.748 19.0	.681 17.3	.343 8.7	.327 8.3	IVORY 	GREEN 	BLUE 	K.S. MODEL KSTP-325-B WITH DIE INDEX NO.:E35

 **ALL LISTED**
ES11742 ©: NOT RU AND C-RU LISTED