

NYLON-INSULATED CORD END TERMINALS (E SERIES)

MAXIMUM ELECTRIC CURRENT:









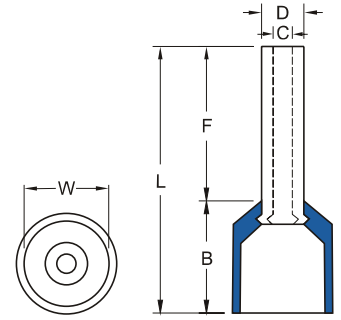





A.W.G.	18	16	14	12	10	8	6
AMP.	17	18	30	35	50	70	95

MAXIMUM ELECTRICAL RATING: 105°C 600 VOLTS MAX.

CONNECTOR MATERIAL: COPPER TUBE.

INSULATION MATERIAL: NYLON



WIRE RANGE A.W.G. mm ²	ITEM NO.	DIMENSION <small>inch mm</small>						FRENCH COLOR	GERMAN COLOR	DIN COLOR	CRIMPING TOOL
		F	L	W	B	D	C				
18 A.W.G. 1.0 mm ²	E1012-L	.472 12.0	.728 18.5	.130 3.3	.256 6.5	.067 1.7	.055 1.4	RED 	YELLOW 	RED 	K.S. MODEL KST2000L WITH DIE INDEX NO: 1 OR K.S. MODEL LY8-060 WITH DIE INDEX NO:1-1.5 OR WACO MODEL VARIOCRIMP 4
	E1018	.709 18.0	.957 24.3	.118 3.0	.248 6.3						
16 A.W.G. 1.5 mm ²	E1506 ©	.236 6.0	.484 12.3	.138 3.5	.248 6.3	.079 2.0	.067 1.7	BLACK 	RED 	BLACK 	K.S. MODEL KST2000L WITH DIE INDEX NO:1.5 OR K.S. MODEL LY8-060 WITH DIE INDEX NO:1-1.5
	E1508	.315 8.0	.551 14.0								
	E1508-L	.315 8.0	.571 14.5								
	E1510	.394 10.0	.630 16.0								
	E1512	.472 12.0	.709 18.0								
	E1512-L	.472 12.0	.728 18.5								
	E1515	.591 15.0	.839 21.3								
	E1518	.709 18.0	.945 24.0								
E1518-L	.709 18.0	.965 24.5	.150 3.8	.256 6.5							
14 A.W.G. 2.5 mm ²	E2508	.315 8.0	.606 15.4	.165 4.2	.291 7.4	.098 2.5	.087 2.2	GREY 	BLUE 	BLUE 	K.S. MODEL KST2000L WITH DIE INDEX NO:2.5 OR K.S. MODEL LY8-060 WITH DIE INDEX NO:2.5
	E2509	.354 9.0	.646 16.4								
	E2510	.394 10.0	.685 17.4								
	E2512	.472 12.0	.764 19.4								
	E2518	.709 18.0	1.00 25.4								
	E2525	.984 25.0	1.276 32.4								
12 A.W.G. 4.0 mm ²	E4009 ©	.354 8.0	.646 16.4	.189 4.8	.291 7.4	.126 3.2	.110 2.8	ORANGE 	GREY 	GREY 	K.S. MODEL KST2000L LY8-060 WITH DIE INDEX NO:4 OR WACO MODEL VARIOCRIMP 4
	E4010	.394 10.0	.669 17.0								
	E4012	.472 12.0	.787 20.0								
	E4018	.709 18.0	1.024 26.0								
10 A.W.G. 6.0 mm ²	E6010 ©	.394 10.0	.728 18.5	.248 6.3	.338 8.5	.154 3.9	.138 3.5	GREEN 	BLACK 	YELLOW 	K.S. MODEL KST2000M(6) LY8-060(6)
	E6012	.472 12.0	.787 20.0								
	E6018	.709 18.0	1.024 26.0								