

NYLON-INSULATED TWIN CORD END TERMINALS (TE SERIES)

MAXIMUM ELECTRIC CURRENT:









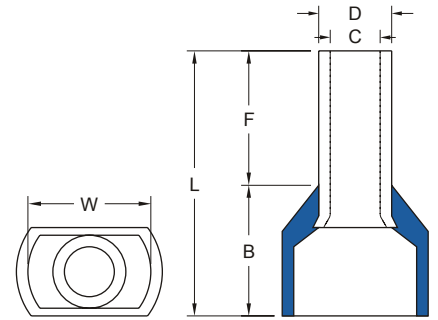









A.W.G.	22	20	18	16	14	12	10	8
AMP.	9	12	17	18	30	35	50	70

MAXIMUM ELECTRICAL RATING: 105°C 600 VOLTS MAX.

CONNECTOR MATERIAL: COPPER TUBE.

INSULATION MATERIAL: NYLON



WIRE RANGE A.W.G. mm ²	ITEM NO.	DIMENSION <small>inch mm</small>						FRENCH COLOR	GERMAN COLOR	DIN COLOR	CRIMPING TOOL
		F	L	W	B	D	C				
2X20 A.W.G. 2X0.5 mm ²	TE0508	.315 8.0	.517 14.5	.197 5.0	.256 6.5	.071 1.8	.055 1.4	WHITE 	ORANGE 	WHITE 	K.S. MODEL LY8-060 WITH DIE INDEX NO.:1-1.5 K.S. MODEL KST2000L WITH DIE INDEX NO.:1
	TE0509	.354 9.0	.610 15.5								
	TE0510	.394 10.0	.650 16.5								
	TE0512	.472 12.0	.728 18.5								
2X18 A.W.G. 2X0.75 mm ²	TE7508	.315 8.0	.579 14.7	.217 5.5	.264 6.7	.083 2.1	.071 1.8	BLUE 	WHITE 	GREY 	K.S. MODEL LY8-060 WITH DIE INDEX NO.:1-1.5 K.S. MODEL KST2000L WITH DIE INDEX NO.:1.5
	TE7510	.394 10.0	.657 16.7								
2X18 A.W.G. 2X1.0 mm ²	TE1008	.315 8.0	.594 15.1	.217 5.5	.280 7.1	.094 2.4	.083 2.1	RED 	YELLOW 	RED 	K.S. MODEL LY8-060 WITH DIE INDEX NO.: 2.5 K.S. MODEL KST2000L WITH DIE INDEX NO.:2.5
	TE1010	.394 10.0	.673 17.1								
2X16 A.W.G. 2X1.5 mm ²	TE1508	.315 8.0	.610 15.5	.252 6.4	.295 7.5	.102 2.6	.091 2.3	BLACK 	RED 	BLACK 	K.S. MODEL KST2000L WITH DIE INDEX NO.:2.5
	TE1510	.394 10.0	.689 17.5								
	TE1512	.472 12.0	.788 19.5								
	TE1515	.591 15.0	.886 22.5								
	TE1518	.709 18.0	1.004 25.5								
2X14 A.W.G. 2X2.5 mm ²	TE2510	.394 10.0	.728 18.5	.315 8.0	.235 8.5	.130 3.3	.114 2.9	GREY 	BLUE 	BLUE 	K.S. MODEL LY8-060 WITH DIE INDEX NO.:4 K.S. MODEL KST2000L WITH DIE INDEX NO.:4
	TE2512	.472 12.0	.807 20.5								
	TE2513	.512 13.0	.846 21.5								
	TE2518	.709 18.0	1.043 26.5								
2X12 A.W.G. 2X4 mm ²	TE4012	.472 12.0	.909 23.1	.339 8.6	.437 11.1	.165 4.2	.150 3.8	ORANGE 	GREY 	GREY 	K.S. MODEL LY8-060 WITH DIE INDEX NO.:6 K.S. MODEL KST8000-TC1208 WITH DIE INDEX NO.:2*12A



ALL LISTED

Ⓢ: NOT RU AND C-RU LISTED