



Slide table cylinder(Cross roller type)——HLS Series

Compendium of HLS\HLSL Series

Multi-adjuster option

Floating joint design
Piston rod needn't endure additional torque

Mounting workpiece from 2 directions

Cross roller type
Cross roller type incorporating the cylinder, it achieves high precision, high rigidity, high load, excellent linearity and non-rotate tolerance.

Mounting cylinder from 3 directions
Through hole for body mounting. Body mounting holes provide 3 mounting positions. Pin holes for positioning.

With magnetic switch slots
There are magnetic switch slots side of the cylinder body convenient to install inducting switch.

Two models (HLS/HLSL) are available

Dual rod structure
Dual rod doubles the output thrust

Standard : HLS

Symmetrical : HLSL

Six bore size are available
Bore size: 6, 8, 12, 16, 20, 25

Criteria for selection: Cylinder thrust

Unit : Newton(N)

Bore size	Rod size	Acting type	Pressure area(mm ²)	Operating pressure(MPa)						
				0.2	0.3	0.4	0.5	0.6	0.7	
6	3	Double acting	Push-side	42	8	13	17	21	25	29
			Pull-side	57	11	17	23	29	34	40
8	4	Double acting	Push-side	75	15	23	30	38	45	53
			Pull-side	101	20	30	40	51	61	71
12	6	Double acting	Push-side	170	34	51	68	85	102	119
			Pull-side	226	45	68	90	113	136	158
16	8	Double acting	Push-side	302	60	91	121	151	181	211
			Pull-side	402	80	121	161	201	241	281
20	10	Double acting	Push-side	471	94	141	188	236	283	330
			Pull-side	628	126	188	251	314	377	440
25	12	Double acting	Push-side	756	151	227	302	378	454	529
			Pull-side	982	186	295	393	491	589	687

Installation and application



1. Dirty substances in the pipe must be eliminated before cylinder is connected with pipeline to prevent the entrance of impurities into the cylinder.
2. The medium used by cylinder should be filtered to 40μm or below .
3. Anti-freezing measure shall be adopted under low temperature environment to prevent moisture freezing.
4. If the cylinder is dismantled and stored for a long time, pay attention to conduct anti-rust treatment to the surface. Anti-dust caps shall be added in air inlet and outlet ports.



Slide table cylinder(Cross roller type)

HLS、HLSL Series



Specification

Bore size(mm)	6	8	12	16	20	25
Acting type	Double acting					
Fluid	Air(to be filtered by 40μm filter element)					
Operating pressure	0.2~0.7MPa(29~100psi)(2.0~7.0bar)		0.15~0.7MPa(22~100psi)(1.5~7.0bar)			
Proof pressure	1.2MPa(175psi)(12.0bar)					
Temperature °C	-20~70					
Speed range mm/s	50~500					
Stroke tolerance	Stroke≤100 $+1.0_0$			Stroke>100 $+1.5_0$		
Cushion type	Bumper(Both ends)、Shock absorber					
Sensor switches	CMSH、DMSH、EMSH					
Port size [Note1]	M5×0.8				1/8"	

[Note1] PT thread, G thread, NPT thread are available.
Refer to P362 for detail of sensor switch.

Symbol



Stroke

Bore size (mm)	Standard stroke (mm)										Max.std stroke	
6	10	20	30	40	50						50	
8	10	20	30	40	50	75					75	
12	10	20	30	40	50	75	100				100	
16	10	20	30	40	50	75	100	125			125	
20	10	20	30	40	50	75	100	125	150			150
25	10	20	30	40	50	75	100	125	150			150

[Note] Consult us for non-standard stroke.

Ordering code

HLS 20 × 30 S AS □

① ② ③ ④ ⑤ ⑥

① Model	② Bore Size	③ Stroke	④ Magnet	⑤ Adjuster option [Note1]		⑥ Thread type [Note2]
HLS: Slide table cylinder (Double acting type) (Cross roller type) HLSL: Symmetrical slide table cylinder (Double acting type) (Cross roller type)	6 8 12 16 20 25	Refer to stroke table for details	S: With magnet	Blank: Without adjuster(Basic type) Extension Retraction		Blank: PT G : G T : NPT
				A: Adjustable rubber stopper(Both ends) ; B: Shock absorber(Both ends)		
				AS: Adjustable rubber stopper(Extension) ; BS: Shock absorber(Extension)		
				AF: Adjustable rubber stopper(Retraction) ; BF: Shock absorber(Retraction)		

[Note1] B type, BS type, BF type are unavailable for bore size of Φ6. [Note2]When the thread is standard, the code is blank.

Slide table cylinder(Cross roller type)

HLS、HLSL Series

Inner structure and material of major parts

Basic type

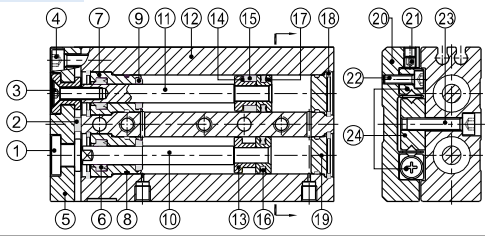

NO.	Item	Material	NO.	Item	Material
1	Floating joint	Carbon steel	13	Magnet holder	Brass
2	Bumper	TPU	14	Magnet washer	NBR
3	Screw	Carbon steel	15	Magnet	Sintered metal (Neodymium-iron-boron)
4	Screw	Carbon steel	16	Piston seal	NBR
5	Fixing plate	Aluminum alloy	17	Piston	Brass
6	Rod seal	NBR	18	C clip	Spring steel
7	Front cover	Aluminum alloy	19	Back cover	Aluminum alloy
8	O-ring	NBR	20	Slide table	Aluminum alloy
9	Bumper	TPU	21	Nut	Carbon steel
10	Piston rod A	Carbon steel	22	Screw	Carbon steel
11	Piston rod B	Stainless steel	23	Screw	Carbon steel
12	Body	Aluminum alloy	24	Slide guidecombination	subassembly

Note: inner structure & material data sheet is based on certain bore size.
Please contact Airtac if you need inner structure & material data sheet for specific bore size.

Model Selection Method

Please select compact cylinder's type according to following procedure, and cross reference with data sheets.

A) Operating conditions(According to mounting position and work form)

1. Model used(Bore size, Stroke)
2. Type of cushion(Bumper, Shock absorber)
3. Mounting position of work(Top, front)
4. Mounting direction(Axial, Vertical)
5. Average speed Va(mm/s)
6. Applied load W(N)
7. Overhang L1, L2, L3(mm)

Fig. 1

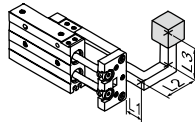

Explain : L1 is the distance of load's center beyond the end plank's plane.
If load's center is not beyond the end plank's plane, L1 is negative.

Fig. 1 : Applied load

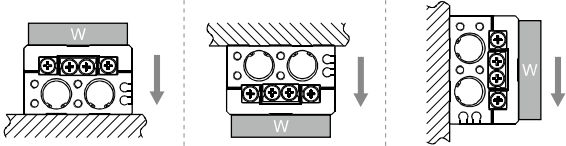

B) Kinetic energy check

1. Calculate kinetic energy of load E(J)

$$E = \frac{1}{2} \times \frac{W}{9.8} \times \left(\frac{1.4 \times Va}{1000} \right)^2$$
2. Calculate allowable kinetic energy Ea(J)

$$Ea = K \times E_{max}$$

K: Mounting work coefficient (Fig 2)
E_{max}: Maximum allowable kinetic energy (Table 1)
3. Check that kinetic energy of load doesn't exceed allowable kinetic energy: E ≤ Ea

C) Load check

1. Calculate allowable applied load Wa (N)

$$Wa = K \times \beta \times W_{max}$$

K: Mounting work coefficient (Fig 2)
W_{max}: Maximum allowable applied load (Table 1)
β: Applied load coefficient (Fig 3)
2. Check that load(W) doesn't exceed allowable applied load(Wa): W ≤ Wa

Fig 2 : Mounting work coefficient (K)

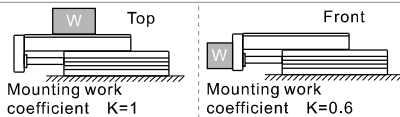
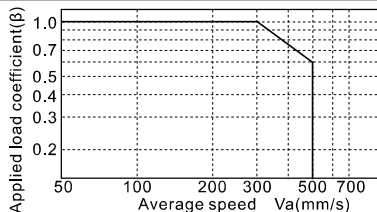

Fig 3 : Applied load coefficient (β)



D) Moment check

Horizontal

1. Calculate actual moment: Mp, Mpo, My, Myo, Mr, Mro (Nm)

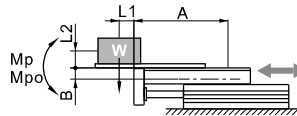

Dynamic moment :

$$Mp = W \times (L1 + A) / 1000$$
 Static moment :

$$Mpo = \frac{W \times (L1 + A)}{1000} + \frac{W \times a \times (L2 + B)}{1000 \times g}$$

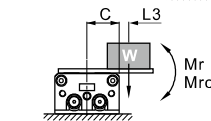

Dynamic moment :

$$Mr = W \times (C + L3) / 1000$$
 Static moment :

$$Mro = (W \times a \times (C + L3)) / 1000 \times g$$

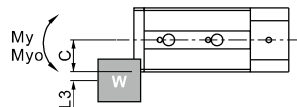

Dynamic moment :

$$My = 0$$
 Static moment :

$$Myo = (W \times a \times (C + L3)) / 1000 \times g$$

2. Check

Dynamic moment :	$\frac{Mp}{Mp_{max}} + \frac{My}{My_{max}} + \frac{Mr}{Mr_{max}} \leq 1$
Static moment :	$\frac{Mpo}{Mpo_{max}} + \frac{Myo}{Myo_{max}} + \frac{Mro}{Mro_{max}} \leq 1$

Vertical

1. Calculate actual moment: Mp, Mpo, My, Myo (Nm)

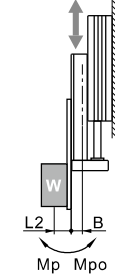

Dynamic moment :

$$Mp = W \times (L2 + B) / 1000$$
 Static moment :

$$Mpo = \frac{W \times (L2 + B)}{1000} + \frac{W \times a \times (L2 + B)}{1000 \times g}$$

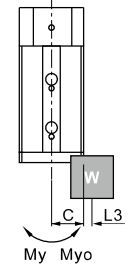

Dynamic moment :

$$My = W \times (C + L3) / 1000$$
 Static moment :

$$Myo = \frac{W \times a \times (C + L3)}{1000 \times g} + \frac{W \times (C + L3)}{1000}$$

2. Check

Dynamic moment :	$\frac{Mp}{Mp_{max}} + \frac{My}{My_{max}} \leq 1$
Static moment :	$\frac{Mpo}{Mpo_{max}} + \frac{Myo}{Myo_{max}} \leq 1$

Explain:

L1/L2/L3: The distance of load center to mount plane (Determined by actuality).
 A/B/C: Correction value for center position distance of moment (Refer to table 2).
 Mp_{max}/My_{max}/Mr_{max}/Mpo_{max}/Myo_{max}/Mro_{max}: Maximum allowable moment (Refer to table 2).
 g: Acceleration of gravity (g=9.81m/s²).
 a: Acceleration of inertia
 (Bumper: a=1600×(Va/1000)², Shock absorber: a=400×(Va/1000)²)
 W: Load weight (Determined by actuality).

Slide table cylinder(Cross roller type)

HLS、HLSL Series

Table 1 : Maximum allowable kinetic energy(Emax)
Maximum allowable applied load(Wmax)

Model	Max. allowable kinetic energy		Emax(J)	Max. allowable applied load Wmax(N)
	Basic type	Rubber stopper type		
HLS6	0.01	0.01	-	4
HLS8	0.024	0.024	0.048	8
HLS12	0.05	0.05	0.1	15
HLS16	0.1	0.1	0.2	30
HLS20	0.13	0.13	0.26	40
HLS25	0.22	0.22	0.44	70

Note: Symbol and unit

Symbol	Item	Unit
A, B, C	Correction value for center position distance of moment	mm
a	Acceleration of inertia	-
E	Kinetic energy	J
Ea	Allowable kinetic energy	J
Emax	Maximum allowable kinetic energy	J
g	Acceleration of gravity $g=9.81$	m/s^2
K	Mounting work coefficient	-
L1, L2, L3	Overhang	mm
Mp, My, Mr	Dynamic moment(Pitch, Yaw, Roll)	Nm
Mp _{max} , My _{max} , Mr _{max}	Maximum allowable dynamic moment (Pitch, Yaw, Roll)	Nm
Mpo, Myo, Mro	Static moment(Pitch, Yaw, Roll)	Nm
Mpo _{max} , Myo _{max} , Mro _{max}	Maximum allowable static moment (Pitch, Yaw, Roll)	Nm
Va	Average speed	mm/s
W	Applied load	N
Wmax	Maximum allowable applied load	N
β	Applied load coefficient	-

Table 2 : Maximum allowable moment(Nm),
Correction value for center position distance of moment(mm)

Bore size	Stroke	Static moment			Dynamic moment			Correction value		
		Mpo _{max}	Myo _{max}	Mro _{max}	Mp _{max}	My _{max}	Mr _{max}	A	B	C
6	10	3.3	3.8	2.6	0.7	0.7	0.6	27	7.3	16
	20	3.3	3.8	2.6	0.7	0.8	0.6	42		
	30	3.3	3.8	2.6	0.7	0.8	0.6	52		
	40	7.2	7.9	3.6	1.3	1.3	0.6	72		
	50	12.4	12.7	4.7	1.8	1.8	0.6	87		
8	10	10.1	9.1	8.8	2.5	2.5	2.0	32	8.5	20
	20	10.1	9.1	8.8	2.6	2.6	2.0	42		
	30	10.1	9.1	8.8	2.8	2.8	2.0	57		
	40	12.4	10.8	10.1	3.4	3.4	2.3	72		
	50	23.6	24.8	13.9	4.4	4.4	2.1	92		
12	75	32.8	35.3	16.4	4.6	4.6	1.8	132	10	25
	10	33.0	34.3	30.9	7.3	7.3	5.8	48		
	20	33.0	34.3	30.9	7.6	7.6	5.8	58		
	30	33.0	34.3	30.9	7.8	7.8	5.8	68		
	40	33.0	34.3	30.9	8.0	8.0	5.8	78		
16	50	53.4	49.6	39.7	9.8	9.8	5.8	88	11	30
	75	78.8	71.9	48.6	14.2	14.2	6.8	125		
	100	78.8	71.9	48.6	14.7	14.7	6.8	160		
	10	33.0	34.3	30.9	8.8	8.8	7.6	43		
	20	33.0	34.3	30.9	9.2	9.2	7.6	53		
20	30	33.0	34.3	30.9	9.5	9.5	7.6	63	16.5	35
	40	33.0	34.3	30.9	10.0	10.0	7.6	78		
	50	53.4	49.6	39.7	12.2	12.2	7.6	93		
	75	78.8	71.9	48.6	17.6	17.6	8.9	130		
	100	78.8	71.9	48.6	18.2	18.2	8.9	165		
25	125	143.7	144.5	53.3	24.8	24.8	7.8	204	20.3	42
	10	60.1	50.5	72.8	14.5	14.5	15.2	47		
	20	60.1	50.5	72.8	15.2	15.2	15.2	57		
	30	60.1	50.5	72.8	15.7	15.7	15.2	67		
	40	60.1	50.5	72.8	16.3	16.3	15.2	82		
30	50	60.1	50.5	72.8	16.6	16.6	15.2	92	20.3	42
	75	169.3	154.3	114.4	41.2	41.2	22.0	136		
	100	169.3	154.3	114.4	42.8	42.8	22.0	176		
	125	169.3	154.3	114.4	43.6	43.6	22.0	205		
	150	267.5	286.6	145.6	49.0	49.0	20.5	249		
40	10	60.1	50.5	72.8	16.3	16.3	17.6	52	20.3	42
	20	60.1	50.5	72.8	17.0	17.0	17.6	62		
	30	60.1	50.5	72.8	17.4	17.4	17.6	72		
	40	60.1	50.5	72.8	17.8	17.8	17.6	82		
	50	60.1	50.5	72.8	18.2	18.2	17.6	96		
50	75	169.3	154.3	114.4	45.2	45.2	25.3	141	20.3	42
	100	169.3	154.3	114.4	46.2	46.2	25.3	165		
	125	169.3	154.3	114.4	48.0	48.0	25.3	210		
	150	267.5	286.6	145.6	65.0	65.0	28.3	254		

Installation and application

1. How to mount cylinder :

1.1) Cylinder can be mounted from 3 directions

Vertical Mounting(Body thread holes)

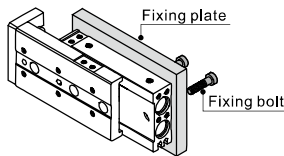

Vertical Mounting(Body through holes)

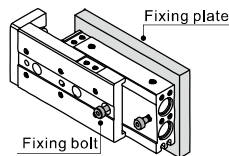

Axial Mounting (Body thread holes)

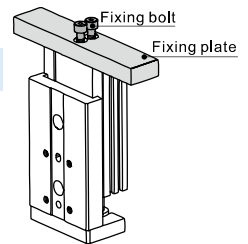

1.2) When mounting an compact slide cylinder, screws of appropriate length should be used and tightened properly within the maximum tightening torque.

If screws are tightened beyond designed limits, malfunction may occur. If they are tightened insufficiently, it may result in sliding or falling off from its position.

Vertical Mounting(Body thread holes)

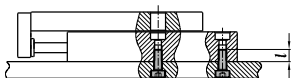

Model	Bolt used	Max. tightening torque (Nm)	Max. screw-in depth(mm)
HLS6	M4×0.7	2.1	8
HLS8	M4×0.7	2.1	8
HLS12	M5×0.8	4.4	10
HLS16	M6×1.0	4.4	10
HLS20	M6×1.0	7.4	12
HLS25	M8×1.25	18.0	16

Vertical Mounting(Body through holes)

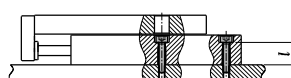

Model	Bolt used	Max. tightening torque (Nm)	Body depth(mm)
HLS6	M3×0.5	1.2	11.0
HLS8	M3×0.5	1.2	12.5
HLS12	M4×0.7	2.8	18.0
HLS16	M5×0.8	5.7	25.0
HLS20	M5×0.8	5.7	28.0
HLS25	M6×1.0	10.0	36.2

Axial Mounting(Body thread holes)

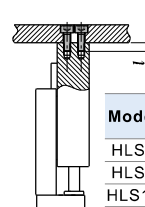

Model	Bolt used	Max. tightening torque (Nm)	Max. screw-in depth(mm)
HLS6	M2.5×0.45	0.5	3.5
HLS8	M3×0.5	0.9	4.0
HLS12	M4×0.7	2.1	6.0
HLS16	M5×0.8	4.4	7.0
HLS20	M5×0.8	4.4	8.0
HLS25	M6×1.0	7.4	10.0

Slide table cylinder(Cross roller type)

HLS、HLSL Series

2. Work Piece Mounting :

2.1) Work pieces can be mounted on 2 surfaces of the compact slide.

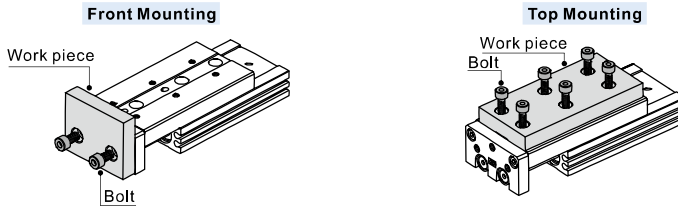

2.2) When mounting a work piece, tighten the bolts properly at a torque value within the limiting range. Use bolts at least 0.5mm shorter than maximum thread depth to prevent bolts from contacting the guide block. If the bolts are too long, they hit the guide block and cause damage.

Front Mounting				Top Mounting			
Model	Bolt used	Max. tightening torque (Nm)	Max. screw-in depth(mm)	Model	Bolt used	Max. tightening torque (Nm)	Max. screw-in depth(mm)
HLS6	M3×0.4	0.9	5	HLS6	M3×0.5	0.9	4.2
HLS8	M4×0.7	2.1	6	HLS8	M3×0.5	0.9	4.5
HLS12	M5×0.8	4.4	8	HLS12	M4×0.7	2.1	5
HLS16	M6×1.0	7.4	10	HLS16	M5×0.8	4.4	6
HLS20	M6×1.0	7.4	13	HLS20	M5×0.8	4.4	9.5
HLS25	M8×1.25	18.0	15	HLS25	M6×1.0	7.4	13

2.3) Since the table is supported by the linear guide, take care not to apply strong impact or large moment to the guide section.

2.4) Hold the slide when fastening work pieces to it with bolts, If the body is held while tightening bolts, excessive moment may damage guide section.

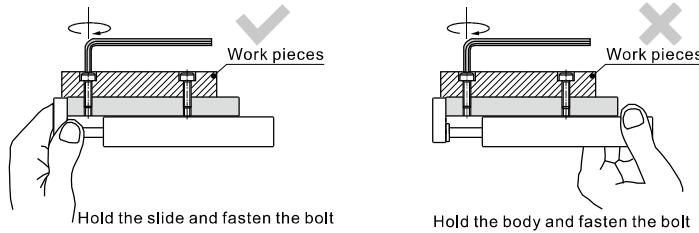

3. About shock absorber :

3.1) Shock absorbers are expendable. Promptly replace them when energy absorbing capacity decreases.

3.2) Never turn or adjust the screws on bottom of the shock absorber body. The screws are not for adjusting. Otherwise would cause oil leakage.

3.3) Follow the table for tightening torque of shock absorber to lock nuts.

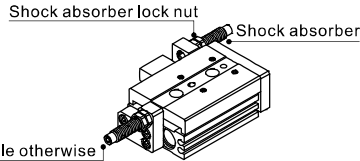

Model	Shock absorber	Tightening torque
HLS6	Without shock absorber	
HLS8	ACA0806-1N	1.67(Nm)
HLS12	ACA0806-1N	1.67(Nm)
HLS16	ACA1007-1N	3.14(Nm)
HLS20	ACA1210-1N	3.14(Nm)
HLS25	ACA1412-1N	10.8(Nm)

4. How to mount sensor switch :

4.1) HLS Series are all with magnet. The matching sensor switches are CMSH、DMSH、EMSH series.

4.2) Maintain a minimum spacing of at least 3mm if two compact cylinders are used side by side in order to avoid malfunction.

5. Make sure to connect the compact cylinder to speed controller at the meter-out side, and the speed of compact cylinder must below 500mm/s.

6. Don't apply a load beyond the range of the operation limits. Different load or torque will cause different deflection to table, please see below for details.

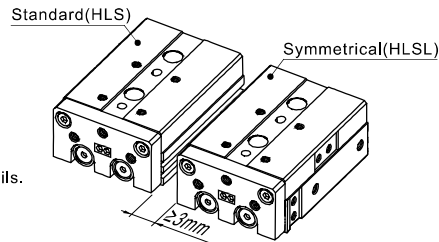

Slide table cylinder(Cross roller type)

HLS、HLSL Series

6.1) Table deflection due to pitch moment:

Table deflection (arrow) when a load acts upon the section marked with the arrow at the full stroke of the compact slide.

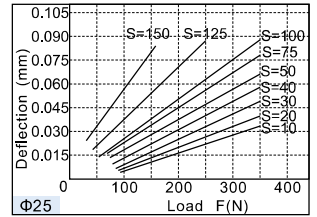
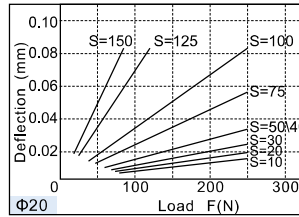
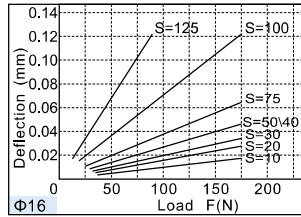
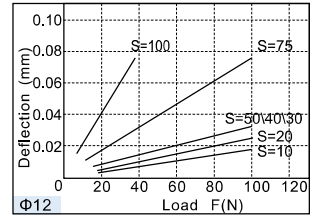
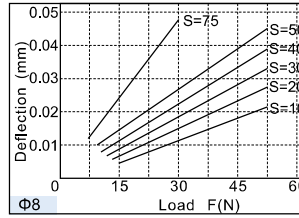
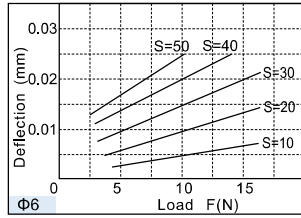

6.2) Table deflection due to yaw moment:

Table deflection (arrow) when a load acts upon the section marked with the arrow at the full stroke of the compact slide.

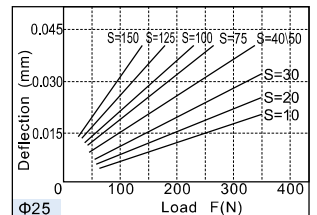
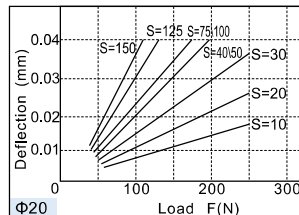
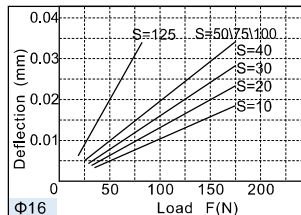
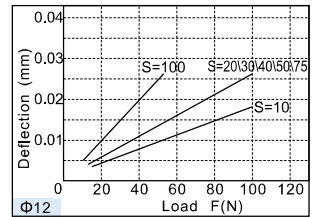
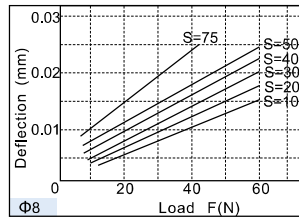
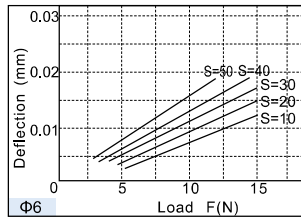
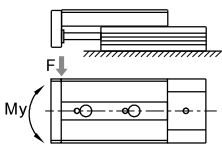

6.3) Table deflection due to roll moment:

Table deflects (A) when a load acts upon section F at the full stroke of the compact slide.

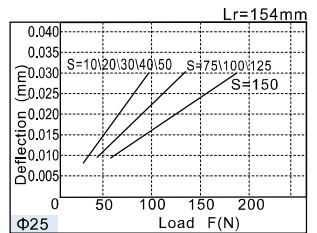
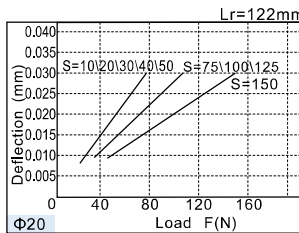
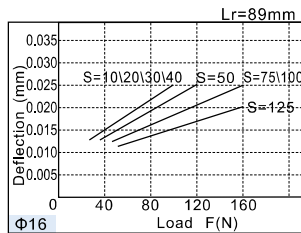
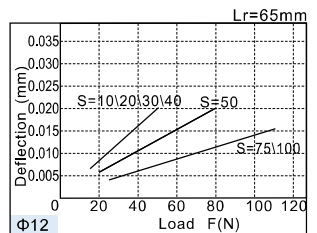
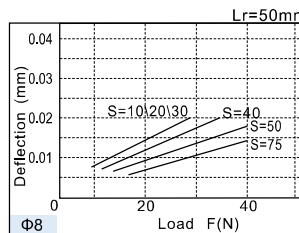
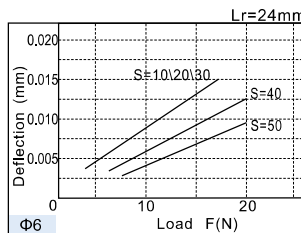
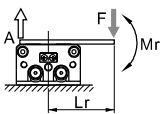

Slide table cylinder(Cross roller type)

HLS、HLSL Series

Dimensions

HLS6

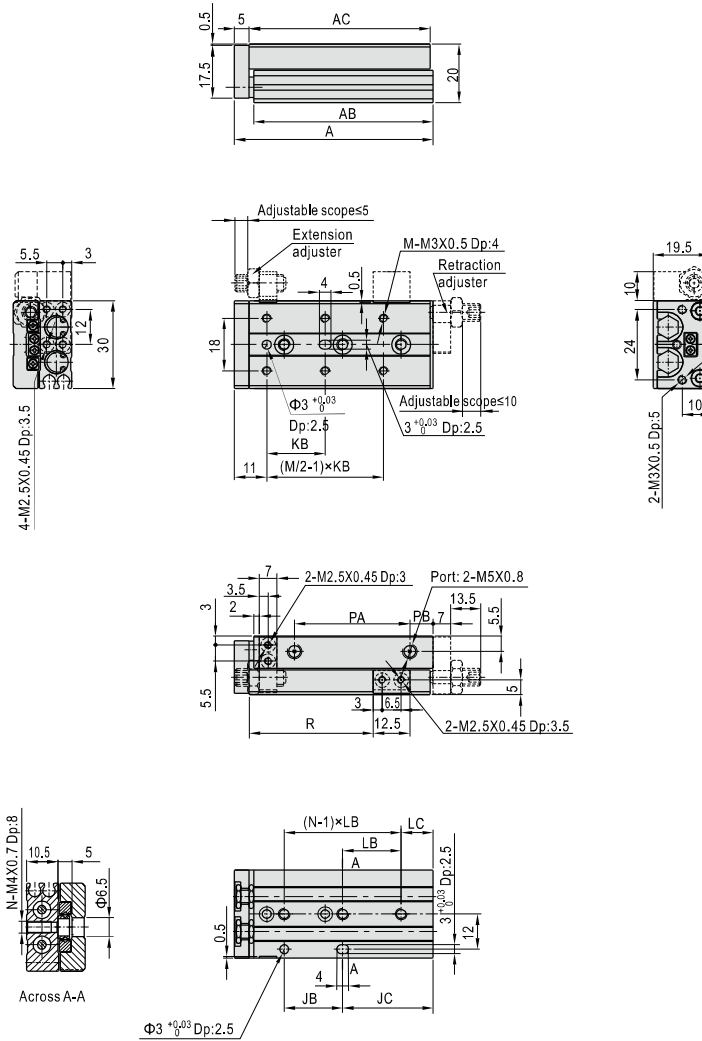

Stroke\Item	A	AB	AC	JB	JC	KB	LB	LC	M	N	PA	PB	R
10	48	41.5	42	20	11	20	25	6	4	2	19	8	21.5
20	58	51.5	52	20	21	30	35	6	4	2	28	9	31.5
30	68	61.5	62	20	31	20	20	11	6	3	39	8	41.5
40	90	83.5	84	30	43	28	30	13	6	3	51	18	51.5
50	106	99.5	100	48	41	38	24	17	6	4	61	24	61.5

Slide table cylinder(Cross roller type)

HLS、HLSL Series

HLSL6

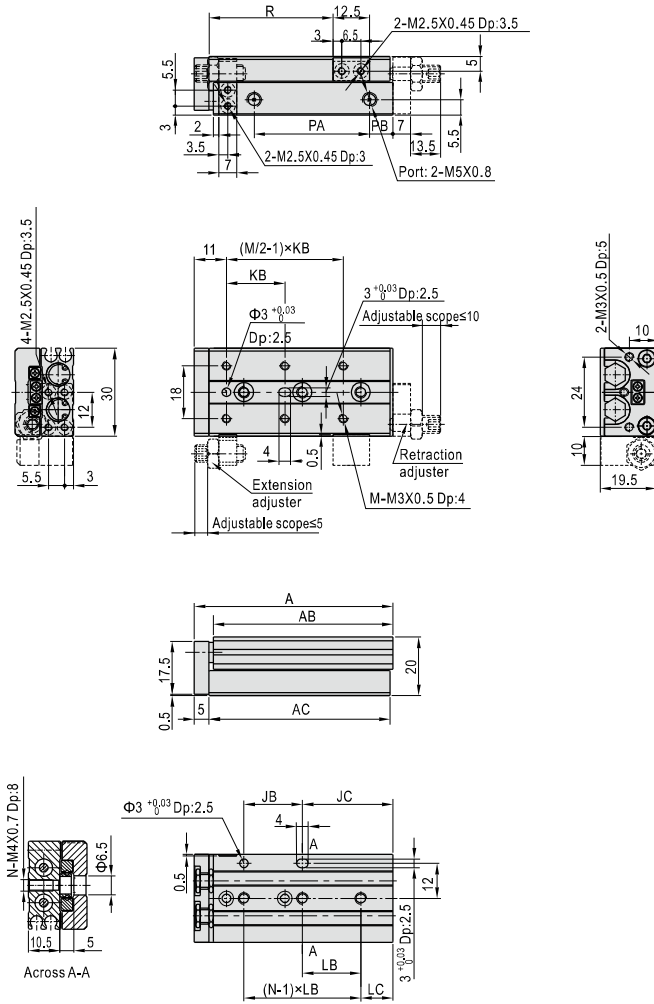

Stroke\Item	A	AB	AC	JB	JC	KB	LB	LC	M	N	PA	PB	R
10	48	41.5	42	20	11	20	25	6	4	2	19	8	21.5
20	58	51.5	52	20	21	30	35	6	4	2	28	9	31.5
30	68	61.5	62	20	31	20	20	11	6	3	39	8	41.5
40	90	83.5	84	30	43	28	30	13	6	3	51	18	51.5
50	106	99.5	100	48	41	38	24	17	6	4	61	24	61.5

Slide table cylinder(Cross roller type)

HLS、HLSL Series

HLS8

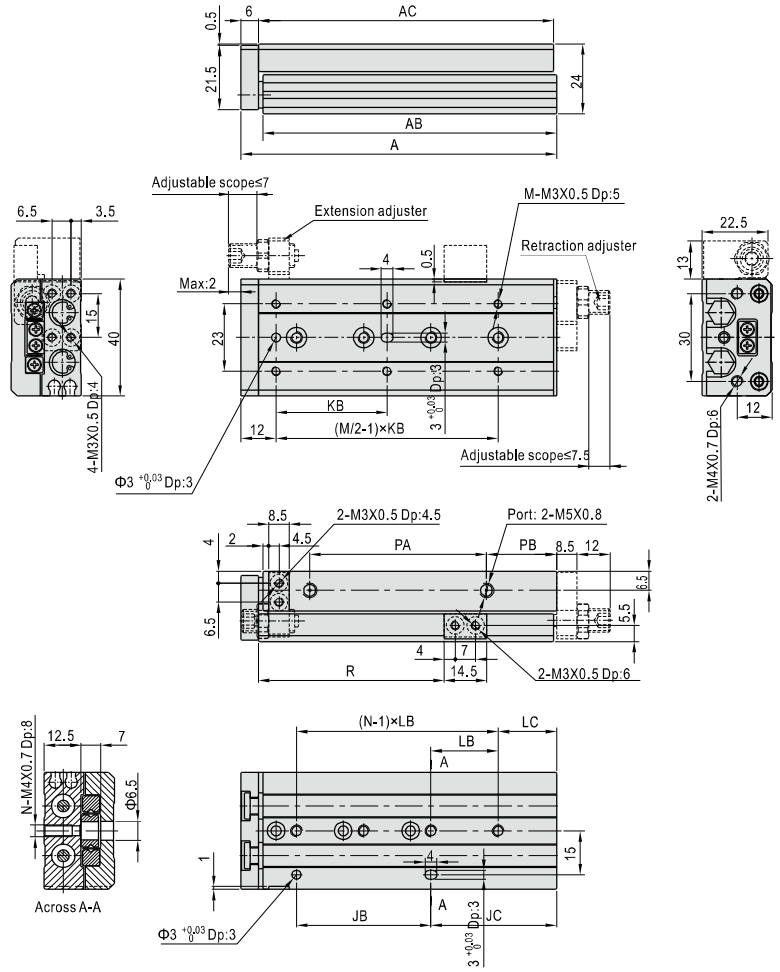

Stroke/Item	A	AB	AC	JB	JC	KB	LB	LC	M	N	PA	PB	R
10	56	48.5	49	20	17	25	28	9	4	2	19.5	12.5	23.5
20	61	53.5	54	30	12	25	30	12	4	2	30	7	33.5
30	72	64.5	65	20	33	40	20	13	4	3	41	7	43.5
40	90	82.5	83	28	43	50	28	15	4	3	56	10	53.5
50	108	100.5	101	46	43	38	23	20	6	4	68	16	63.5
75	158	150.5	151	56	83	50	28	27	6	5	94	40	88.5

HLS8(With shock absorber)

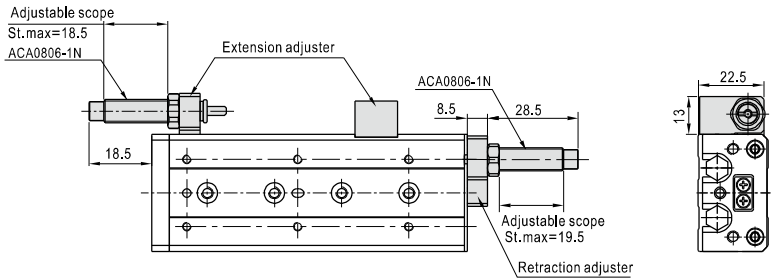

Slide table cylinder(Cross roller type)

HLS、HLSL Series

HLSL8

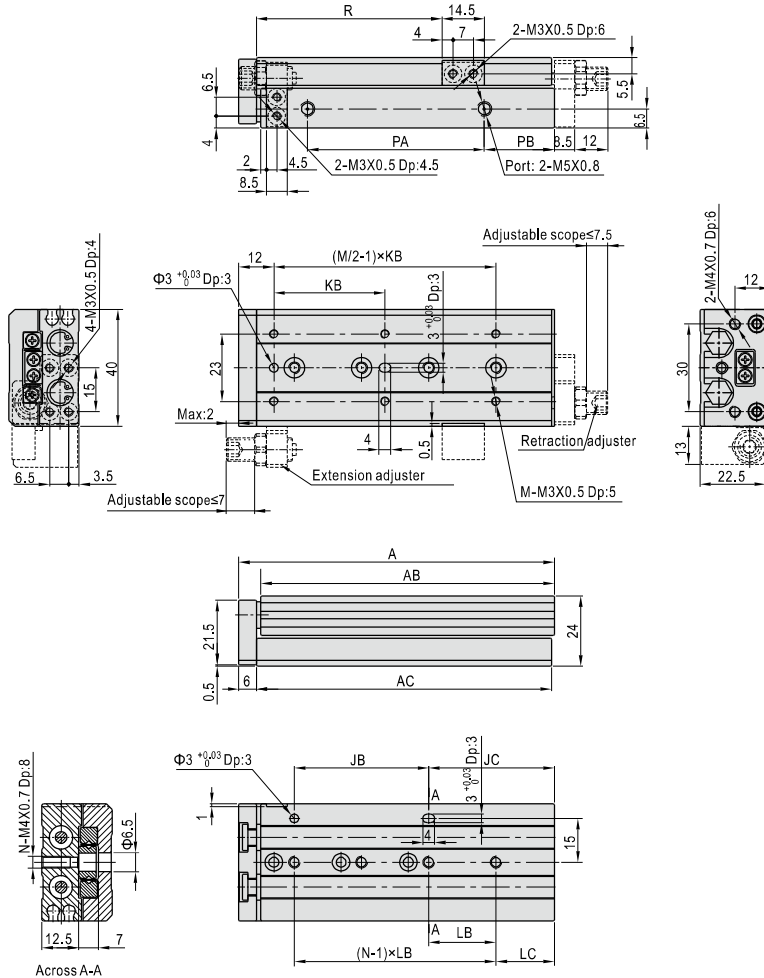

Stroke/Item	A	AB	AC	JB	JC	KB	LB	LC	M	N	PA	PB	R
10	56	48.5	49	20	17	25	28	9	4	2	19.5	12.5	23.5
20	61	53.5	54	30	12	25	30	12	4	2	30	7	33.5
30	72	64.5	65	20	33	40	20	13	4	3	41	7	43.5
40	90	82.5	83	28	43	50	28	15	4	3	56	10	53.5
50	108	100.5	101	46	43	38	23	20	6	4	68	16	63.5
75	158	150.5	151	56	83	50	28	27	6	5	94	40	88.5

HLSL8(With shock absorber)

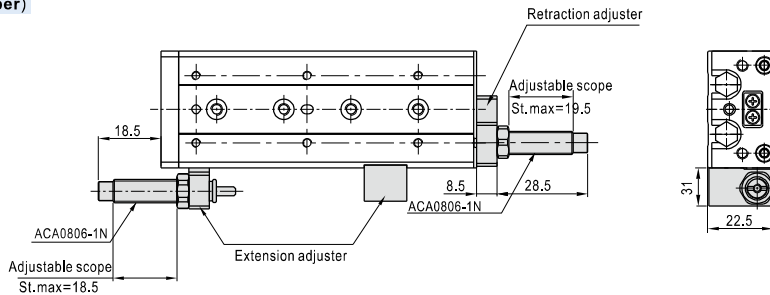

Slide table cylinder(Cross roller type)

HLS、HLSL Series

HLS12

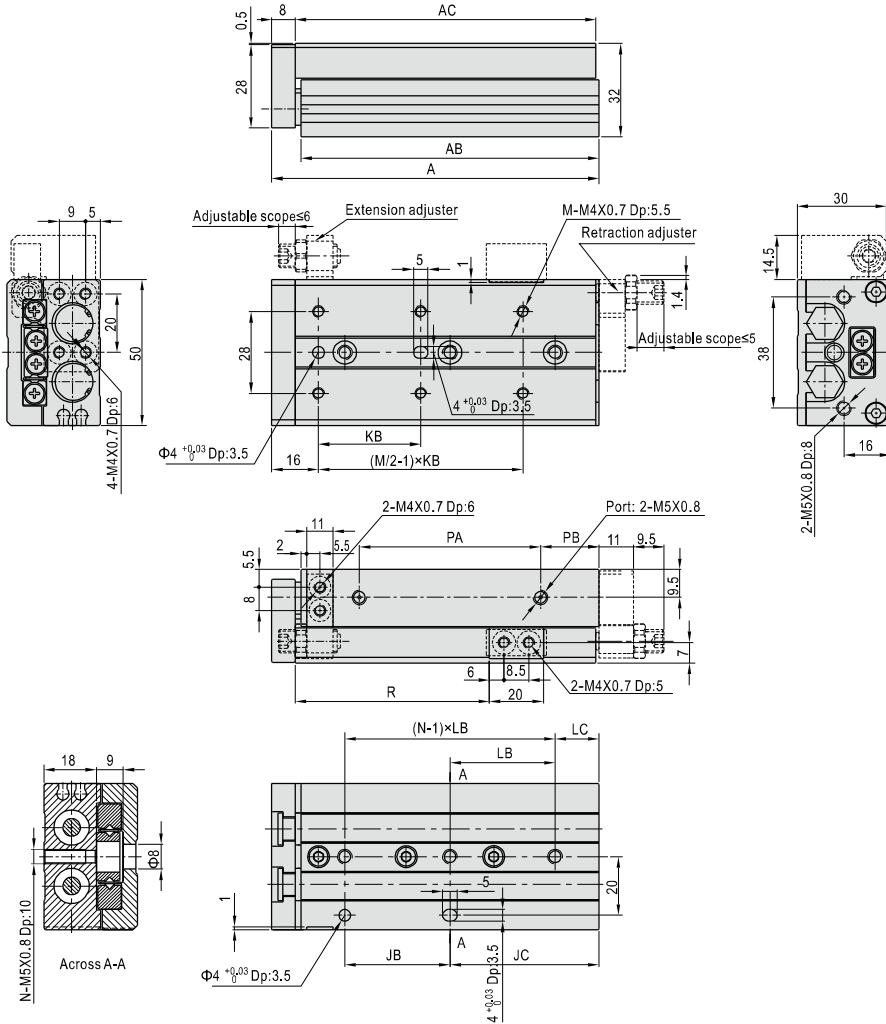

Stroke\Item	A	AB	AC	JB	JC	KB	LB	LC	M	N	PA	PB	R
10	80	70	71	40	15	35	40	15	4	2	39.5	10	25
20	80	70	71	40	15	35	40	15	4	2	39.5	10	35
30	80	70	71	40	15	35	40	15	4	2	39.5	10	45
40	92	82	83	25	42	50	25	17	4	3	51.5	10	55
50	112	102	103	36	51	35	36	15	6	3	61.5	20	65
75	158	148	149	72	61	55	36	25	6	4	87.5	40	90
100	212	202	203	76	111	65	38	35	6	5	131.5	50	115

HLS12(With shock absorber)

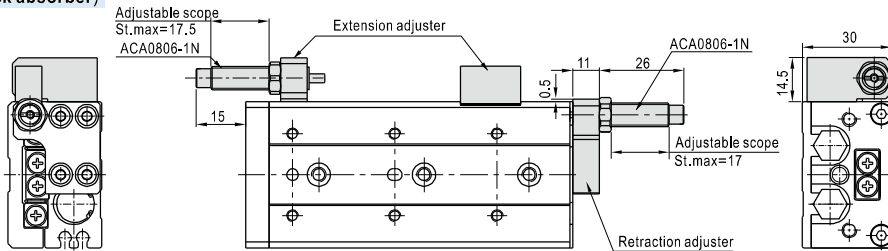

Slide table cylinder(Cross roller type)

HLS、HLSL Series

HLSL12

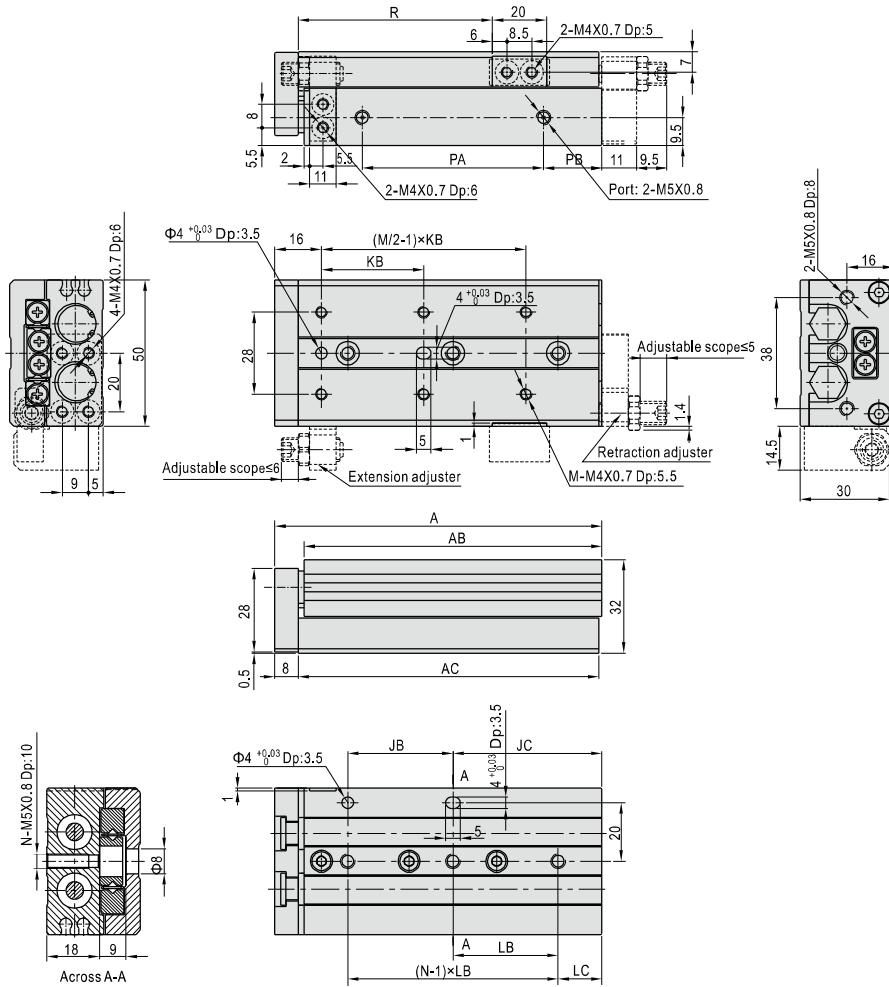

Stroke\Item	A	AB	AC	JB	JC	KB	LB	LC	M	N	PA	PB	R
10	80	70	71	40	15	35	40	15	4	2	39.5	10	25
20	80	70	71	40	15	35	40	15	4	2	39.5	10	35
30	80	70	71	40	15	35	40	15	4	2	39.5	10	45
40	92	82	83	25	42	50	25	17	4	3	51.5	10	55
50	112	102	103	36	51	35	36	15	6	3	61.5	20	65
75	158	148	149	72	61	55	36	25	6	4	87.5	40	90
100	212	202	203	76	111	65	38	35	6	5	131.5	50	115

HLSL12(With shock absorber)

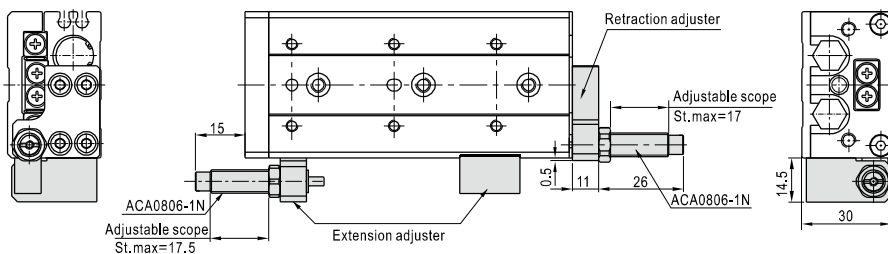

Slide table cylinder(Cross roller type)

HLS、HLSL Series

HLS16

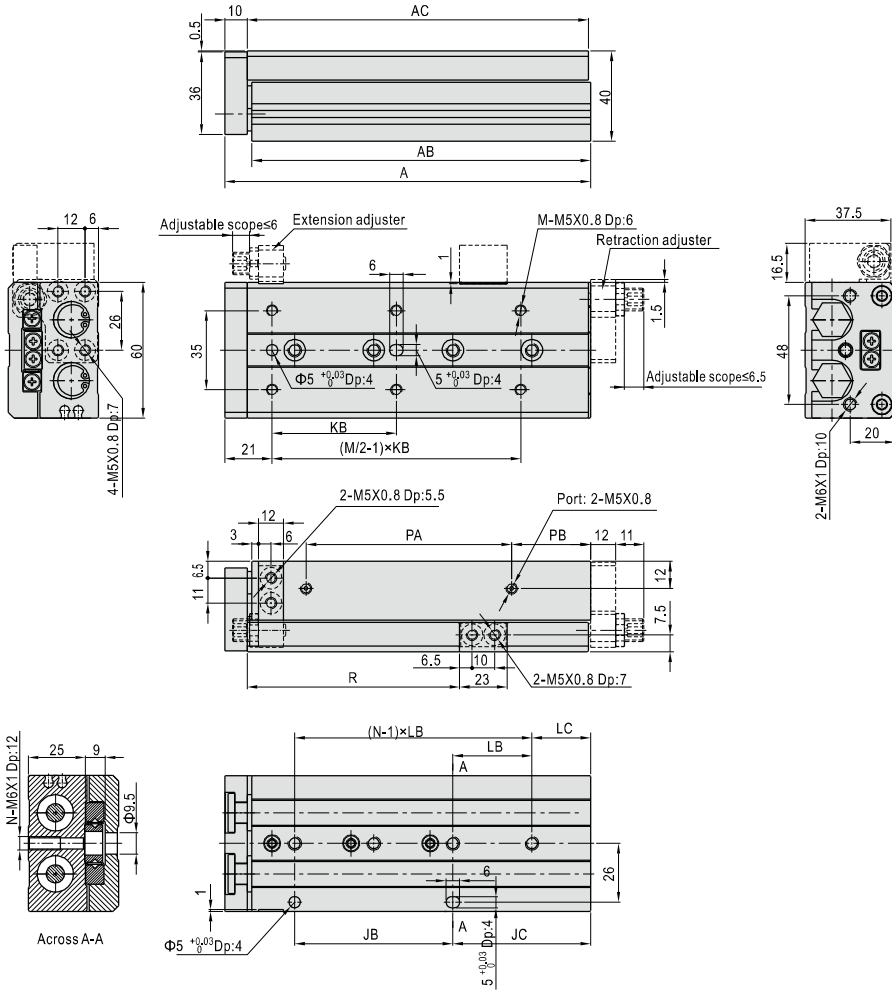

Stroke\Item	A	AB	AC	JB	JC	KB	LB	LC	M	N	PA	PB	R
10	87	75	76	40	16	35	40	16	4	2	42.5	8	28.5
20	87	75	76	40	16	35	40	16	4	2	42.5	8	38.5
30	87	75	76	40	16	35	40	16	4	2	42.5	8	48.5
40	97	85	86	50	16	40	50	16	4	2	52.5	8	58.5
50	112	100	101	30	51	30	30	21	6	3	63.5	12	68.5
75	162	150	151	70	61	55	35	26	6	4	90.5	35	93.5
100	210	198	199	70	109	65	35	39	6	5	118.5	55	118.8
125	260	248	249	70	159	70	35	19	8	7	153.5	70	143.5

HLS16(With shock absorber)

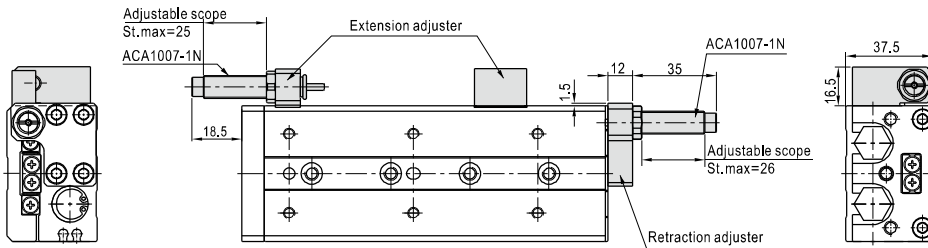

Slide table cylinder(Cross roller type)

HLS、HLSL Series

HLSL16

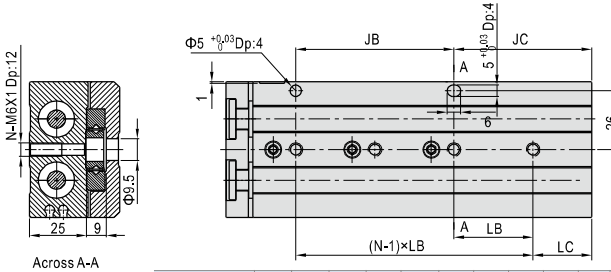
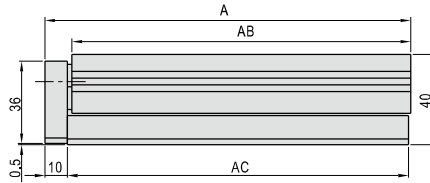
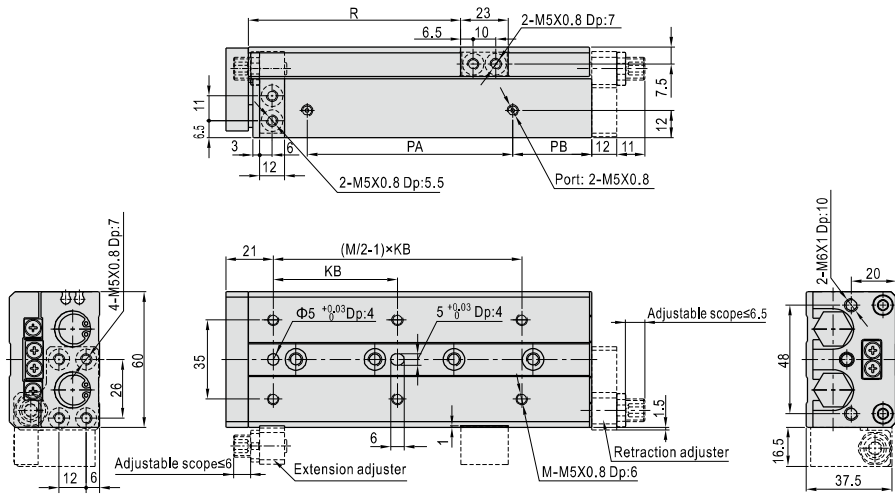

Across A-A

Stroke/Item	A	AB	AC	JB	JC	KB	LB	LC	M	N	PA	PB	R
10	87	75	76	40	16	35	40	16	4	2	42.5	8	28.5
20	87	75	76	40	16	35	40	16	4	2	42.5	8	38.5
30	87	75	76	40	16	35	40	16	4	2	42.5	8	48.5
40	97	85	86	50	16	40	50	16	4	2	52.5	8	58.5
50	112	100	101	30	51	30	30	21	6	3	63.5	12	68.5
75	162	150	151	70	61	55	35	26	6	4	90.5	35	93.5
100	210	198	199	70	109	65	35	39	6	5	118.5	55	118.8
125	260	248	249	70	159	70	35	19	8	7	153.5	70	143.5

HLSL16(With shock absorber)

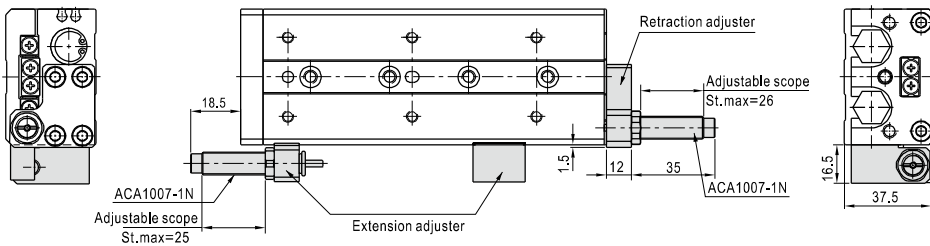

Slide table cylinder(Cross roller type)

HLS、HLSL Series

HLS20

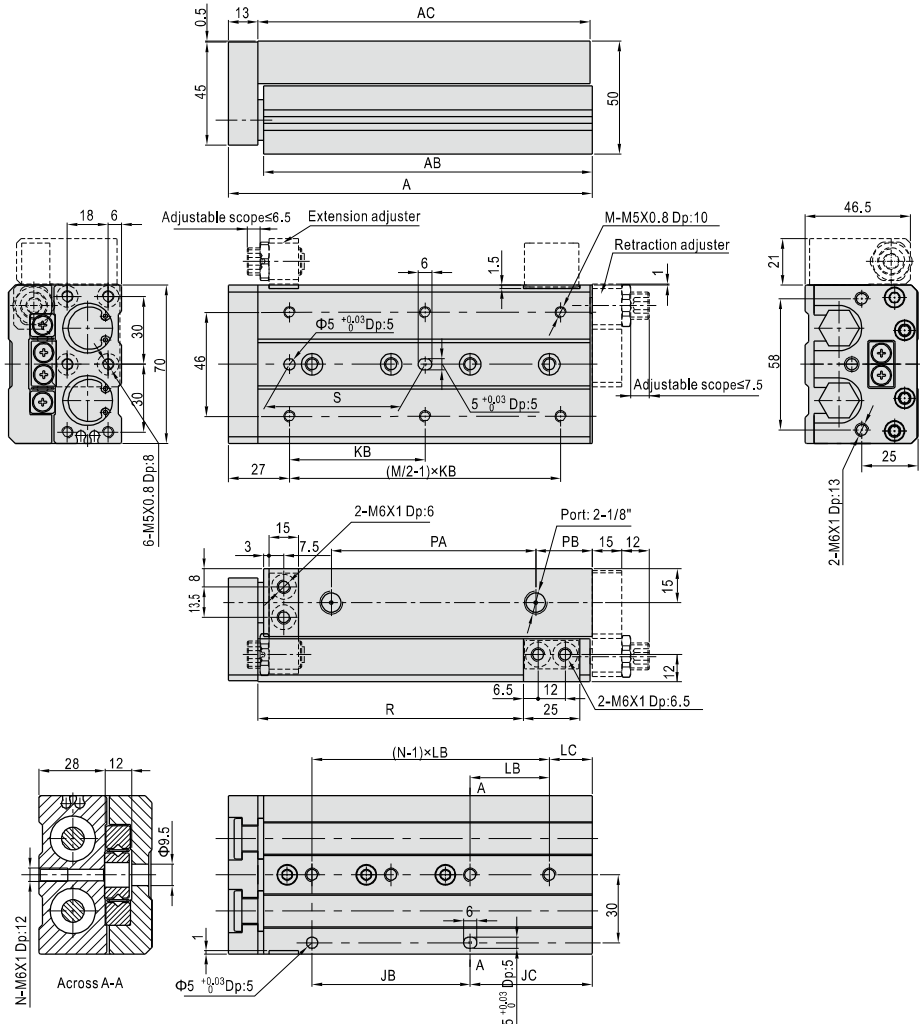

Stroke/Item	A	AB	AC	JB	JC	KB	LB	LC	M	N	S	PA	PB	R
10	97	81.5	83	35	25	50	45	15	4	2	40	43.5	10	32.5
20	97	81.5	83	35	25	50	45	15	4	2	40	43.5	10	42.5
30	97	81.5	83	35	25	50	45	15	4	2	40	43.5	10	52.5
40	107	91.5	93	35	35	60	55	15	4	2	50	53.5	10	62.5
50	122	106.5	108	35	50	35	35	15	6	3	35	68.5	10	72.5
75	161	145.5	147	70	54	60	35	19	6	4	60	107.5	10	97.5
100	214	198.5	200	70	107	70	35	37	6	5	70	115.5	55	122.5
125	268	252.5	254	76	155	70	38	41	8	6	70	154.5	70	147.5
150	320	304.5	306	88	195	80	44	19	8	7	80	186.5	90	172.5

HLS20(With shock absorber)

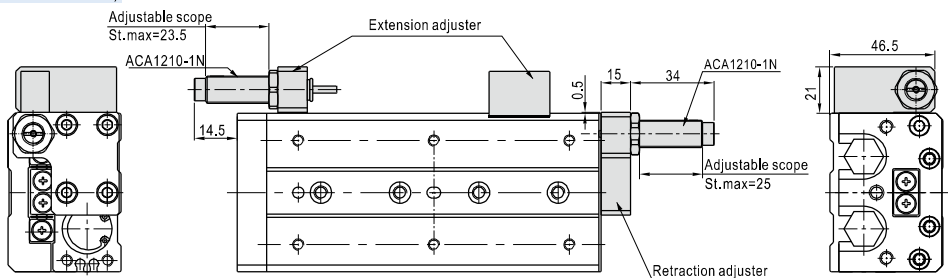

Slide table cylinder(Cross roller type)

HLS、HLSL Series

HLSL20

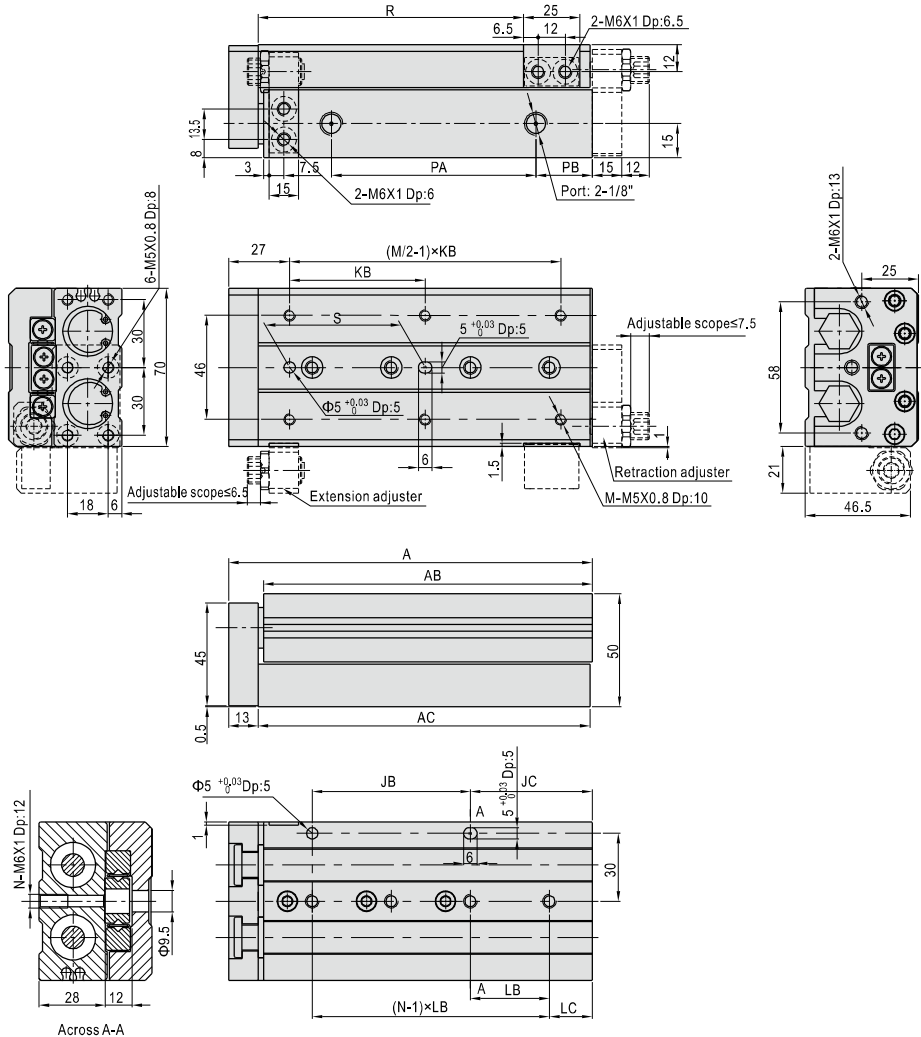

Stroke\Item	A	AB	AC	JB	JC	KB	LB	LC	M	N	S	PA	PB	R
10	97	81.5	83	35	25	50	45	15	4	2	40	43.5	10	32.5
20	97	81.5	83	35	25	50	45	15	4	2	40	43.5	10	42.5
30	97	81.5	83	35	25	50	45	15	4	2	40	43.5	10	52.5
40	107	91.5	93	35	35	60	55	15	4	2	50	53.5	10	62.5
50	122	106.5	108	35	50	35	35	15	6	3	35	68.5	10	72.5
75	161	145.5	147	70	54	60	35	19	6	4	60	107.5	10	97.5
100	214	198.5	200	70	107	70	35	37	6	5	70	115.5	55	122.5
125	268	252.5	254	76	155	70	38	41	8	6	70	154.5	70	147.5
150	320	304.5	306	88	195	80	44	19	8	7	80	186.5	90	172.5

HLSL20(With shock absorber)

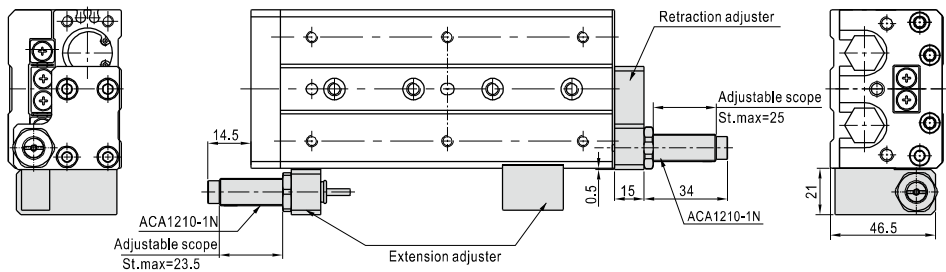

Slide table cylinder(Cross roller type)

HLS、HLSL Series

HLS25

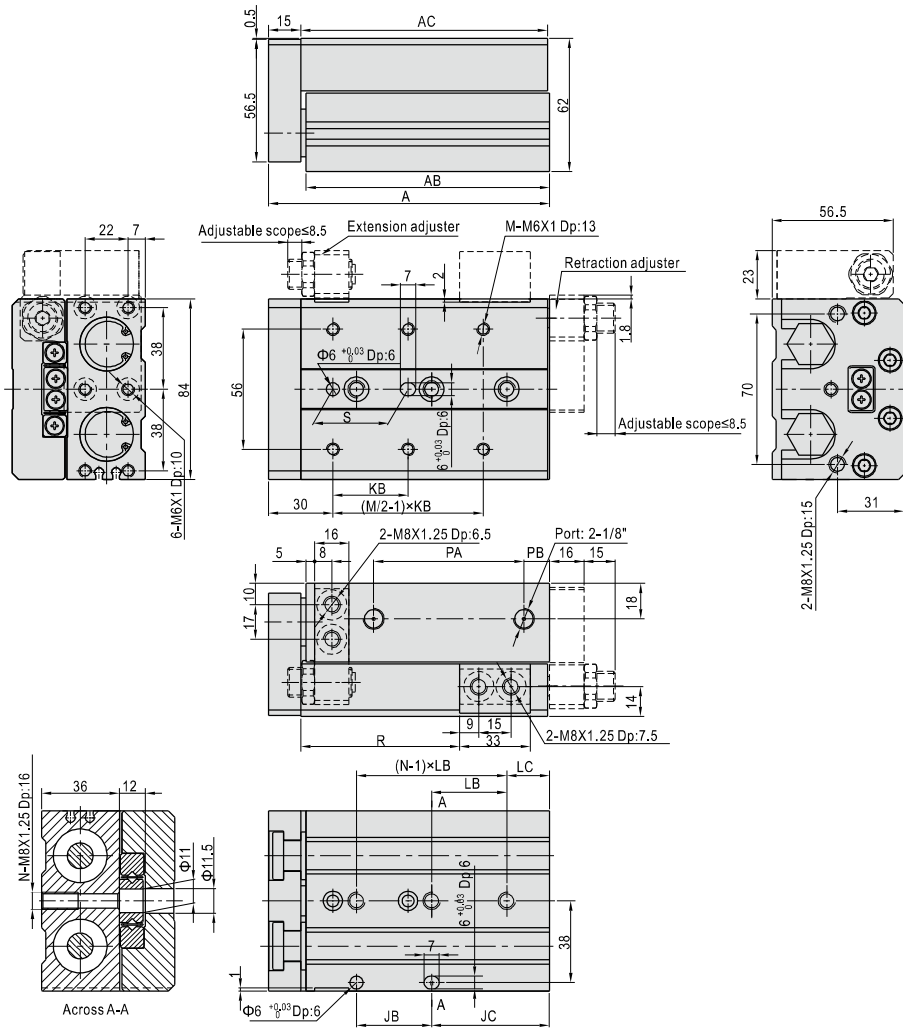

Stroke\Item	A	AB	AC	JB	JC	KB	LB	LC	M	N	S	PA	PB	R
10	108	90.5	92	45	22	50	45	22	4	2	40	47	12	35
20	108	90.5	92	45	22	50	45	22	4	2	40	47	12	45
30	108	90.5	92	45	22	50	45	22	4	2	40	47	12	55
40	118	100.5	102	55	22	60	55	22	4	2	50	57	12	65
50	131	113.5	115	35	55	35	35	20	6	3	35	70	12	75
75	172	154.5	156	70	61	60	35	26	6	4	60	90	33	100
100	213	195.5	197	70	102	70	35	32	6	5	70	119	45	125
125	271	253.5	255	76	154	75	38	40	8	6	75	155	67	150
150	311	293.5	295	80	190	80	40	30	8	7	80	180	82	175

HLS25(With shock absorber)

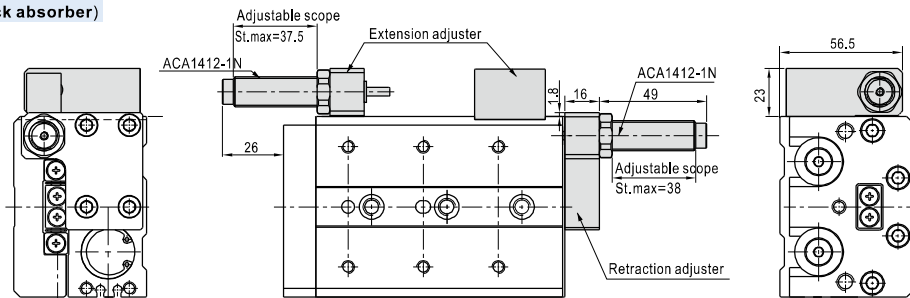

Slide table cylinder(Cross roller type)

HLS、HLSL Series

HLSL25

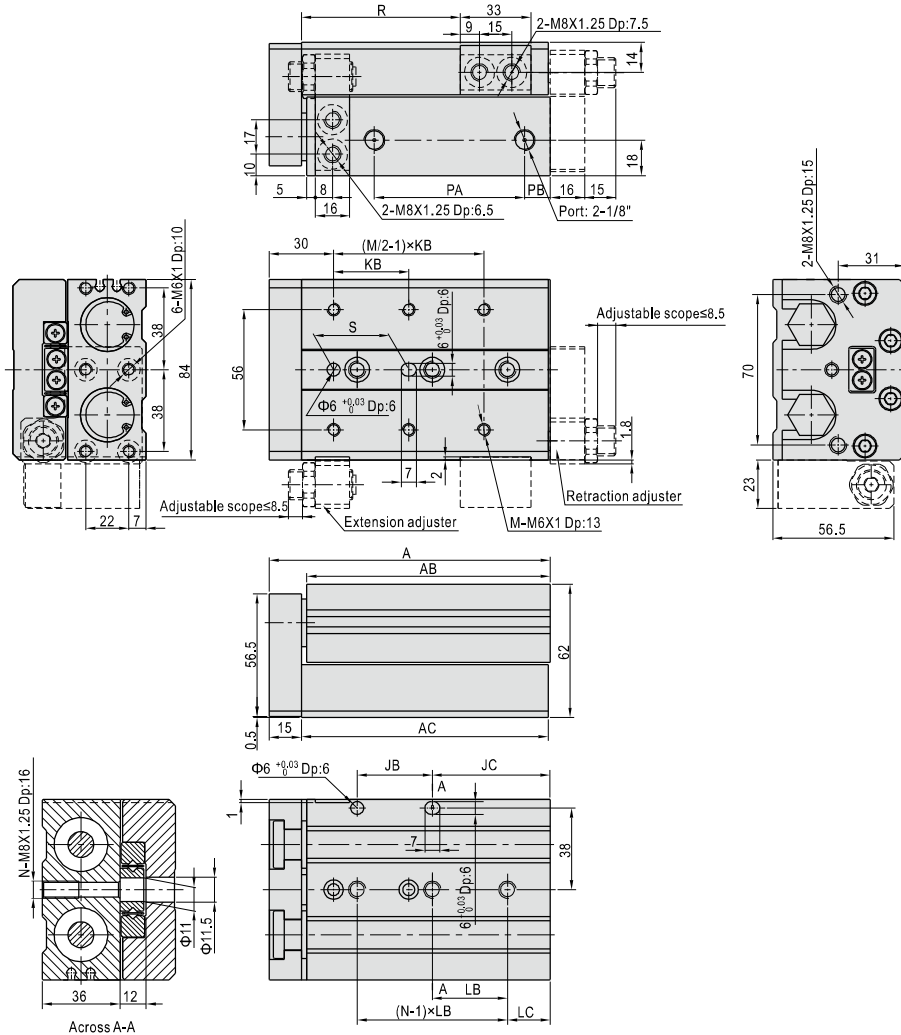

Stroke/Item	A	AB	AC	JB	JC	KB	LB	LC	M	N	S	PA	PB	R
10	108	90.5	92	45	22	50	45	22	4	2	40	47	12	35
20	108	90.5	92	45	22	50	45	22	4	2	40	47	12	45
30	108	90.5	92	45	22	50	45	22	4	2	40	47	12	55
40	118	100.5	102	55	22	60	55	22	4	2	50	57	12	65
50	131	113.5	115	35	55	35	35	20	6	3	35	70	12	75
75	172	154.5	156	70	61	60	35	26	6	4	60	90	33	100
100	213	195.5	197	70	102	70	35	32	6	5	70	119	45	125
125	271	253.5	255	76	154	75	38	40	8	6	75	155	67	150
150	311	293.5	295	80	190	80	40	30	8	7	80	180	82	175

HLSL25(With shock absorber)

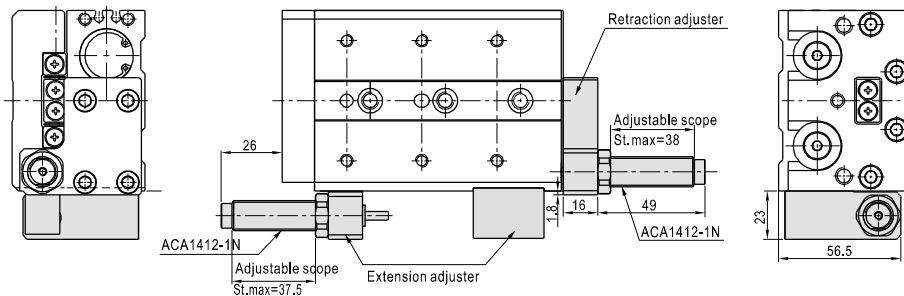

Slide table cylinder(Cross roller type)

HLS、HLSL Series—Accessories

Accessory selection

		Accessories\Bore size	6	8	12
Standard (HLS)	Both ends	A(Adjustable rubber stopper)	F-HLQ6A	F-HLS8A	F-HLS12A
		B(Shock absorber)	x	F-HLS8B	F-HLS12B
	Extension	AS(Adjustable rubber stopper)	F-HLS6AS	F-HLS8AS	F-HLS12AS
		BS(Shock absorber)	x	F-HLQ8BS	F-HLQ12BS
	Retraction	AF(Adjustable rubber stopper)	F-HLQ6AF	F-HLS8AF	F-HLS12AF
		BF(Shock absorber)	x	F-HLS8BF	F-HLS12BF
		Accessories\Bore size	16	20	25
Standard (HLS)	Both ends	A(Adjustable rubber stopper)	F-HLS16A	F-HLS20A	F-HLS25A
		B(Shock absorber)	F-HLS16B	F-HLS20B	F-HLS25B
	Extension	AS(Adjustable rubber stopper)	F-HLS16AS	F-HLS20AS	F-HLS25AS
		BS(Shock absorber)	F-HLQ16BS	F-HLQ20BS	F-HLQ25BS
	Retraction	AF(Adjustable rubber stopper)	F-HLS16AF	F-HLS20AF	F-HLS25AF
		BF(Shock absorber)	F-HLS16BF	F-HLS20BF	F-HLS25BF
		Accessories\Bore size	6	8	12
Symmetrical (HLSL)	Both ends	A(Adjustable rubber stopper)	F-HLQL6A	F-HLSL8A	F-HLSL12A
		B(Shock absorber)	x	F-HLSL8B	F-HLSL12B
	Extension	AS(Adjustable rubber stopper)	F-HLS6AS	F-HLS8AS	F-HLS12AS
		BS(Shock absorber)	x	F-HLQ8BS	F-HLQ12BS
	Retraction	AF(Adjustable rubber stopper)	F-HLQL6AF	F-HLSL8AF	F-HLSL12AF
		BF(Shock absorber)	x	F-HLSL8BF	F-HLSL12BF
		Accessories\Bore size	16	20	25
Symmetrical (HLSL)	Both ends	A(Adjustable rubber stopper)	F-HLSL16A	F-HLSL20A	F-HLSL25A
		B(Shock absorber)	F-HLSL16B	F-HLSL20B	F-HLSL25B
	Extension	AS(Adjustable rubber stopper)	F-HLS16AS	F-HLS20AS	F-HLS25AS
		BS(Shock absorber)	F-HLQ16BS	F-HLQ20BS	F-HLQ25BS
	Retraction	AF(Adjustable rubber stopper)	F-HLSL16AF	F-HLSL20AF	F-HLSL25AF
		BF(Shock absorber)	F-HLSL16BF	F-HLSL20BF	F-HLSL25BF

Note): A=AS+AF; B=BS+BF.

F - HLS 20 AF			
① Accessory	② Cylinder model	③ Bore size	④ Accessory type[Note]
	HLS: Standard	6	A: Adjustable rubber stopper(Both ends)
	HLSL: Symmetrical	8	AS: Adjustable rubber stopper(Extension)
		12	AF: Adjustable rubber stopper(Retraction)
		16	B: Shock absorber (Both ends)
		20	BF: Shock absorber (Retraction)
		25	

[Note]The list accessories are for HLS cylinder. Accessories that are adaptable to other cylinder are not shown. Please refer to accessory list for selection and ordering information.

Dimensions

AS: Adjustable rubber stopper(Extension)

Body Mounting

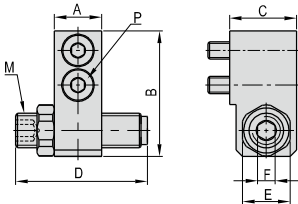
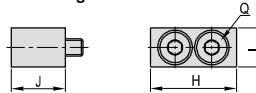

Table Mounting



Bore size\Item	Adjusting stroke range	A	B	C	D	E	F	M	P	H	I	J	Q
6	5	7	19	10.5	16.5	8	3	M6×1.0	M2.5 Length:10	12.5	6.5	10.5	M2.5 Length:10
8	5	8.5	21.5	14	21.5	11	4	M8×1.0	M3 Length:14	14.5	8	12	M3 Length:14
12	5	11	29	15.5	21.5	11	4	M8×1.0	M4 Length:16	20	9	13.5	M4 Length:12
16	5	12	36	17.5	24	14	5	M10×1.0	M5 Length:16	23	10.5	17	M5 Length:16
20	5	15	44.5	22	28	17	6	M12×1.0	M6 Length:20	25	12.5	21	M6 Length:20
25	5	16	53.5	24	32	19	6	M14×1.5	M8 Length:20	33	16.5	23	M8 Length:20

BS: Shock absorber(Extension)

Body Mounting

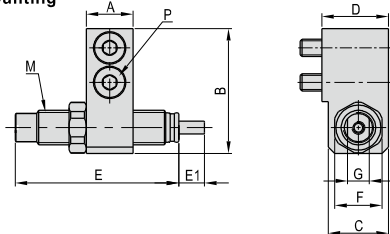
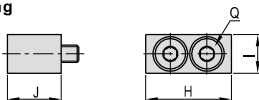

Table Mounting



Bore size\Item	A	B	C	D	E	E1	F	G	M	P	H	I	J	Q
8	8.5	21.5	12.5	14	40	6	11	7	M8×1.0	M3 Length:14	14.5	8	12	M3 Length:14
12	11	29	14	15.5	40	6	11	7	M8×1.0	M4 Length:16	20	9	13.5	M4 Length:12
16	12	36	16	17.5	49	7	14	9	M10×1.0	M5 Length:16	23	10.5	17	M5 Length:16
20	15	44.5	20	22	53.5	10	17	11	M12×1.0	M6 Length:20	25	12.5	21	M6 Length:20
25	16	53.5	22	24	68.5	12	19	12	M14×1.5	M8 Length:20	33	16.5	23	M8 Length:20

Slide table cylinder(Cross roller type)

HLS、HLSL Series—Accessories

AF: Adjustable rubber stopper(Retraction)

For standard type

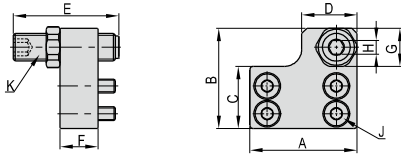

For symmetrical type

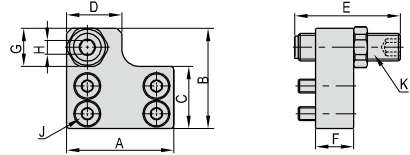

Bore size\Item	Adjusting stroke range	A	B	C	D	E	F	G	H	J	K
6	5	18	19	11	8	21.5	7	8	3	M2.5 Length:6	M6×1.0
8	5	24	22.5	13	14	21.5	8.5	11	4	M3 Length:8	M8×1.0
12	5	31	29	18	16	21.5	11	11	4	M4 Length:12	M8×1.0
16	5	37	37.5	23	18	24	12	14	5	M5 Length:12	M10×1.0
20	5	45.5	47	28.5	23	28	15	17	6	M5 Length:16	M12×1.0
25	5	54	56	34	28	32	16	19	6	M6 Length:18	M14×1.5

BF: Shock absorber(Retraction)

For standard type

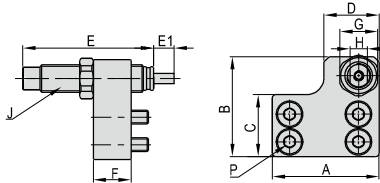

For symmetrical type

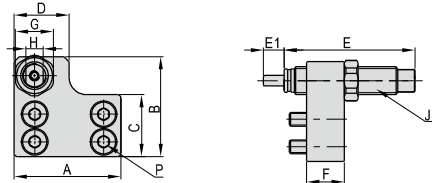

Bore size\Item	A	B	C	D	E	E1	F	G	H	J	P
8	24	22.5	13	14	40	6	8.5	11	7	M8×1.0	M3 Length:8
12	31	29	18	16	40	6	11	11	7	M8×1.0	M4 Length:12
16	37	37.5	23	18	49	7	12	14	9	M10×1.0	M5 Length:12
20	45.5	47	28.5	23	53.5	10	15	17	11	M12×1.0	M5 Length:16
25	54	56	34	28	68.5	12	16	19	12	M14×1.5	M6 Length:18